

PRODUCT *Guide*



Welcome to our planet

Bath Planet offers you out of this world service at a down to Earth price. We are THE home remodeling company with the backing of the prestigious Good Housekeeping Seal.

Relax and review this catalog of products. Know that you're about to enter a new world of stress-free remodeling.



Table of contents

BATHTUBS

STANDARD SIZE REPLACEMENT BATHTUBS.....	3
CUSTOM ACRYLIC SPRAY FOAM BATHTUBS.....	9
ACRYLIC BATHTUB LINERS.....	13
WALK-IN & WALK-THRU.....	15
BATHTUB DRAINS.....	29

SHOWERS

STANDARD SIZE REPLACEMENT SHOWER BASES.....	33
CUSTOM ACRYLIC SPRAY FOAM SHOWER BASES.....	37
ACRYLIC SHOWER LINER BASES.....	45
SHOWER DRAINS.....	47

WALLS

ACRYLIC.....	49
REVEAL LASER-ETCHED WALLS.....	65

ACCESSORIES

WAINSCOT & TRIMS	69
ACRYLIC ACCESSORIES.....	73
METAL FIXTURES & ACCESSORIES.....	83

BATHTUB & SHOWER SEATING.....	107
GLASS ENCLOSURES.....	115
INSTALLATION ACCESSORIES.....	129
SALES TOOLS.....	139
CARE AND MAINTENANCE.....	144
PRODUCT WARRANTY.....	145

Standard Size Replacement

BathTubs



STANDARD SIZE ACRYLIC REPLACEMENT BATHTUB MATRIX

PRODUCT STYLES		DIMENSIONS	COLORS				
			White	Almond	Biscuit	Gray	Sandbar
REPLACEMENT TUBS WITH SKIRT	Classic	60" x 30" x 15" L/R	X	X	X	X	X
	Straight	60" x 30" x 15" L/R	X	X	X	X	X
	Straight (AFR)	60" x 30" x 18" L/R	X				
	Classic	60" x 32" x 15" L/R	X	X	X	X	X
	Straight	60" x 32" x 15" L/R	X	X	X	X	X
SOAKER TUBS	Straight	60" x 32" x 19" L/R	X	X	X	X	X
	Contour	60" x 32" x 19" L/R	X	X	X	X	X
	Linear	60" x 32" x 19" L/R	X	X	X	X	X
	Linear	60" x 36" x 19" L/R	X	X	X	X	X

AFR = Above Floor Rough

STANDARD SIZE ACRYLIC REPLACEMENT BATHTUBS

Our distinctive line of replacement bathtubs and a variety of stylish skirts make these the ideal solution for outdated bathroom remodeling projects.

- One-piece acrylic construction with integrated skirt
- Built-in nail flange
- Constructed from durable ABS-backed acrylic
- Reinforced with structural fiberglass



STANDARD SIZE ACRYLIC REPLACEMENT BATHTUB AND SOAKER STRAIGHT SKIRT

- One-piece acrylic construction with integrated skirt
- Constructed from durable ABS-backed acrylic
- Reinforced with structural fiberglass
- Soaker Tub features built-in arm and head rests
- **Dimensions:**
 - 60" L x 30" W x 15" D
 - 60" L x 32" W x 15" D
 - 60" L x 30" W x 18" D - AFR (Above Floor Rough)
 - 60" L x 32" W x 19" D - Soaker Tub with armrest

NOTE: In-stock item.



STANDARD SIZE ACRYLIC REPLACEMENT BATHTUB CLASSIC

- One-piece acrylic construction with integrated skirt
- Color matched to Bath Planet's existing products
- Constructed from durable ABS-backed acrylic
- Reinforced with structural fiberglass
- Right or left hand option
- **Dimensions:**
 - 60" L x 30" W x 15" D
 - 60" L x 32" W x 15" D

NOTE: In-stock item.

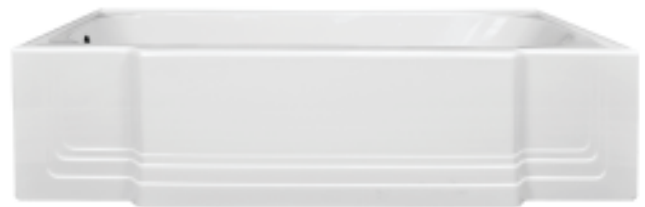

STANDARD SIZE ACRYLIC REPLACEMENT BATHTUB AND SOAKER CONTOUR

The ideal replacement for outdated bathtubs.

- One-piece acrylic construction with integrated skirt
- Available in White, Almond, Biscuit, Gray and Sandbar
- Constructed from durable ABS-backed acrylic
- Reinforced with structural fiberglass
- **Dimensions:**
60" L x 32" W x 19" D

NOTE: *Curved rail cannot accommodate shower doors*

In-stock item.



STANDARD SIZE ACRYLIC REPLACEMENT SOAKER BATHTUB LINEAR

The ideal replacement for outdated bathtubs.

- One-piece acrylic construction with integrated skirt
- Available in White, Almond, Biscuit, Gray and Sandbar
- Constructed from durable ABS-backed acrylic
- Reinforced with structural fiberglass
- **Dimensions:**
60" L x 32" W x 19" D soaker
60" L x 36" W x 19" D soaker
- Right or left hand option

NOTE: *In-stock item.*





Custom Acrylic Spray Foam

Bathtubs



CUSTOM ACRYLIC SPRAY FOAM BATHTUBS

Our distinctive line of replacement bathtubs and a variety of stylish skirts make these the ideal solution for outdated bathroom remodeling projects.

- Constructed from durable ABS-backed acrylic
- Reinforced with high density structural foam

NOTE: Not a stocked item.

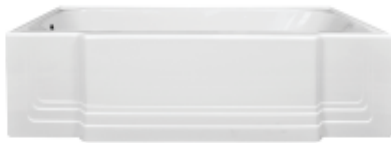

Classic = SFCL
(Offset: 1.5")



Straight = SFST
(No offset)



Wave = SFWA
(No offset)

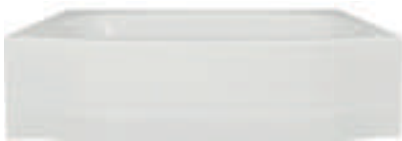

Curved = SFCU
(Offset: 2.75")



Surf = SFSU
(No offset)



Winged = SFWG
(Offset: 1.5")

	Depth (inches)	Width (inches)	Skirt
5.5 FT	15"	30, 31, 32, 33, 34	Straight, Classic, Winged
	17" Soaker	30, 31, 32, 33, 34	Straight, Classic, Winged
5 FT	Depth	Width	Skirt
	13"	30, 31, 32	Straight, Classic, Curved, Surf, Wave, Winged
	13"	28, 29, 33, 34	Straight
	15"	31, 32	Straight, Classic, Curved, Surf, Wave, Winged
	15"	30	Straight, Classic, Wave, Winged
	15"	33, 34	Straight
	17" Soaker	30, 31, 32, 33, 34	Straight
19" Soaker	32	Straight - (New deep soaker with stylish armrests - in white only)	
4.5 FT	Depth	Width	Skirt
	13"	30, 31, 32	Straight, Wave, Winged
	13"	28, 29	Straight
	15"	30, 31, 32	Straight, Surf, Wave, Winged
17" Soaker	30, 31, 32	Straight	
4 FT	Depth	Width	Skirt
	12"	28, 29, 30	Straight
15"	28, 29, 30	Straight	

*All lengths available in increments of .5" from:

- 4' = 48"-50"
- 4.5' = 52"-56"
- 5' = 58"-62"
- 5.5' = 64"-66"

SPRAY FOAM DEEP SOAKER TUBS

Soaker tubs are deeper than a standard tub and include built-in armrests for added comfort.

- Available in: White, Biscuit, Almond, Gray and Sandbar in several skirt designs
- Constructed from DR-ABS acrylic
- Requires Drain, Overflow Waste Assembly

NOTE: Not a stocked item.



An optional neck rest adds comfort to your soaker tub experience.

- Available in: Gray





Acrylic Bathtub

Liners



ACRYLIC BATHTUB LINERS

Our distinctive line of acrylic bathtubs and a variety of stylish skirts make these the ideal solution for outdated bathroom remodeling projects.

- Constructed from durable ABS-backed acrylic
 - Available in 4.5', 5' and 5.5' Tubs

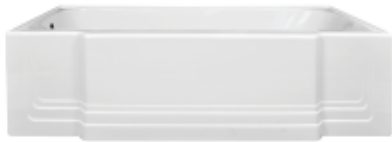

Classic = SFCL
(Offset: 1.5")



Straight = SFST
(No offset)



Wave = SFWA
(No offset)

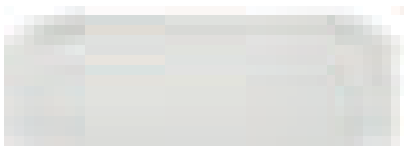

Curved = SFCU
(Offset: 2.75")



Surf = SFSU
(No offset)

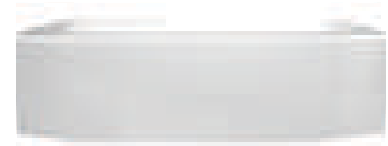

Winged = SFWG
(Offset: 1.5")

NOTE: 12 Key dimensions and a minimum of 2 descriptive photographs are required to identify tub style.
Please check measurement form prior to placing an order.

PRODUCT STYLES		DIMENSIONS	COLORS				
			White	Almond	Biscuit	Gray	Sandbar
BATHTUB LINERS	Curved	4.5' x Custom Width/Depth	X	X	X	X	X
	Straight	4.5' x Custom Width/Depth	X	X	X	X	X
	Surf	4.5' x Custom Width/Depth	X	X	X	X	X
	Winged	4.5' x Custom Width/Depth	X	X	X	X	X
	Classic	5' x Custom Width/Depth	X	X	X	X	X
	Curved	5' x Custom Width/Depth	X	X	X	X	X
	Straight	5' x Custom Width/Depth	X	X	X	X	X
	Wave	5' x Custom Width/Depth	X	X	X	X	X
	Winged	5' x Custom Width/Depth	X	X	X	X	X
	Classic	5.5' x Custom Width/Depth	X	X	X		
	Straight	5.5' x Custom Width/Depth	X	X	X	X	X
	Winged	5.5' x Custom Width/Depth	X	X	X		

Walk-In & and Walk-Thru

Tubs



WALK-IN AND WALK-THRU TUB MATRIX

PRODUCT STYLES		DIMENSIONS	COLORS	
			White	Biscuit
WALK-IN TUBS	LA-3053 Alexis	29 ³ / ₄ " x 53" x 37 ¹ / ₂ "	X	X
	LA-3060 Buckingham	30" x 60" x 36"	X	X
	LA-3052 Geneva	29 ³ / ₄ " x 53" x 37 ¹ / ₂ "	X	X
	LA-2848 Grove	28" x 47 ¹ / ₂ " x 40"	X	X
	LA-3252W Lincoln	31 ³ / ₄ " x 51 ¹ / ₂ " x 40 ¹ / ₄ "	X	X
	LA-3052W Zurich	29 ³ / ₄ " x 52" x 40 ¹ / ₄ "	X	X
WALK-THRU INSERT	Small	Maximum Rail 4 ³ / ₄ "	X	
	Medium	Maximum Rail 5 ³ / ₄ "	X	
	Large	Maximum Rail 7 ³ / ₄ "	X	



With the Alexis Walk-In Bathtub, bathing at home is effortless, safe and soothing.

- Available in: White and Biscuit
- 67 Gallon capacity, 1.5 HP water pump, 1000 W air blower, 1500 W in-line heater
- Designed to fit through any doorway 30" or larger
- Constructed from durable Gel Coat
- 17" h x 24" w ADA-Compliant seat
- 10 Water jets massage the body to relieve aches and pains
- 18 Air spa jets release thousands of tiny bubbles creating a caressing massage
- Chromatherapy, aromatherapy and ozonator
- Bath bead sachet bags available for purchase in lavender, eucalyptus and jasmine.
- **Dimensions:** 53" W x 37.5" H x 29.875" D

In Stock



10 WATER JETS



18 AIR SPA JETS



**BATH CONCEPTS (BCI)
SACHET BAGS
AVAILABLE FOR ORDER**

Standard Therapies on your Alexis Walk-in Tub

- Hydrotherapy jet massage has 10 water jets that massage and relax the body
- Air bubble therapy with 18 air spa jets release thousands of tiny bubbles creating a gentle caressing massage
- Color chromatherapy uses colored lights in water to improve one's mood and enhances relaxation
- Aromatherapy sachet bags are available to enhance your bathing experience
- Ozone therapy and purification aids in healing skin conditions



Top View

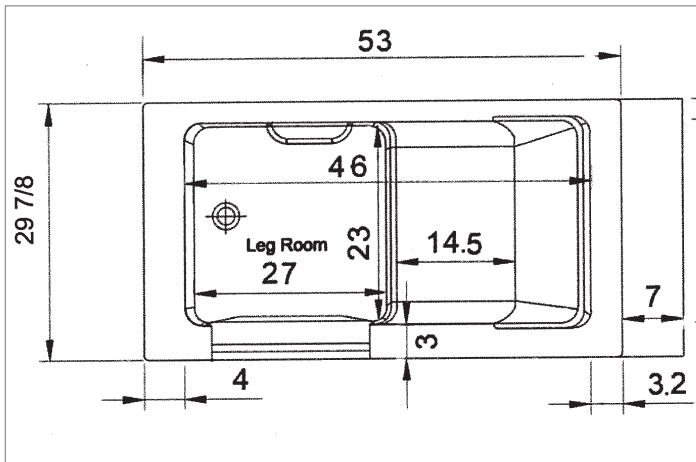

Side View

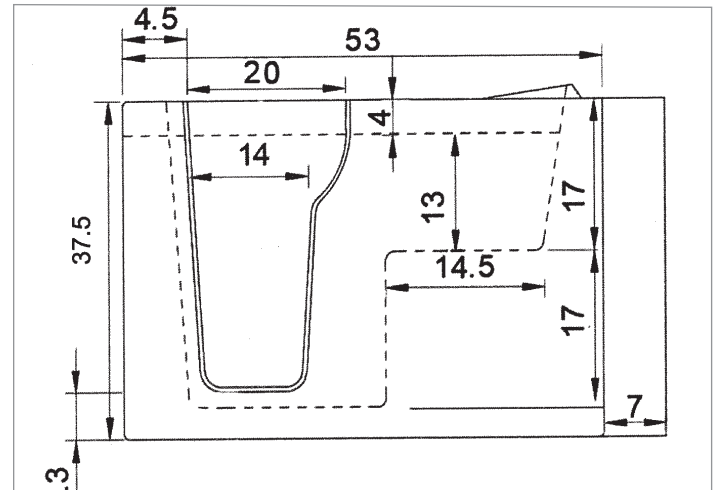

WALK-IN TUBS LA-3060 BUCKINGHAM

A tub that provides comfort with its extra wide seat and ample room to stretch your legs.

- Available in: White and Biscuit
- Marine-Grade Fiberglass & Resin Composite Tub Shell
- High-Gloss, Triple-Coated Gel Coat Finish
- One-Piece, Stainless-Steel Support Frame
- 6 Adjustable Leveling Legs
- Low, 6" Door Threshold
- Ergonomic, Push/Pull Door Handle
- Water-Tight Door Seal
- Inward Swinging Door
- 17" High, ADA-Compliant, Contoured Seat
- Neck Pillow
- **Dimensions:** 30" W x 60" L x 36" H
- Right or Left Hand Option

***Special Order**



Top View

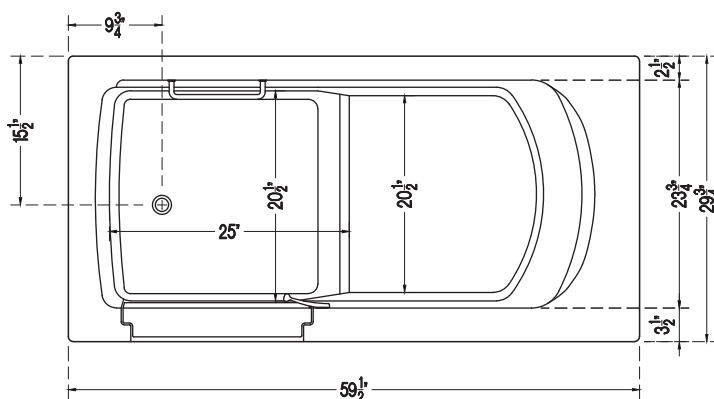

Side View

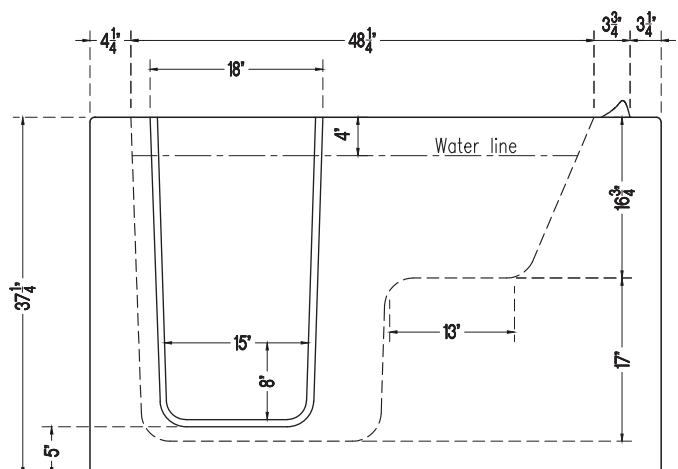

WALK-IN TUBS LA-3052 GENEVA

Boasting a high tub basin, this tub allows for deeper upper body water immersion while maintaining a compact footprint.

- Available in: White and Biscuit
- Marine-Grade Fiberglass & Resin Composite Tub Shell
- High-Gloss, Triple-Coated Gel Coat Finish
- One-Piece, Stainless-Steel Support Frame
- 6 Adjustable Leveling Legs
- Low, 6" Door Threshold
- Ergonomic, Push/Pull Door Handle
- Water-Tight Door Seal
- Inward Swinging Door
- 17" High, ADA-Compliant, Contoured Seat
- Neck Pillow
- **Dimensions:** 29 ¾" W x 53" L x 37 ½" H
- Right or Left Hand Option

***Special Order**



Top View

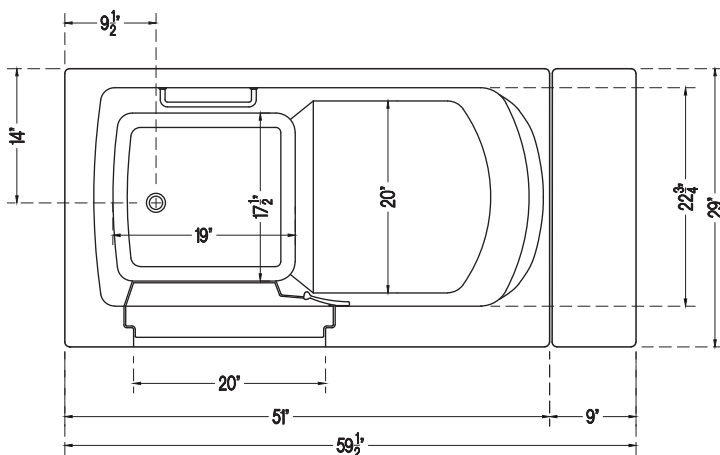

Side View

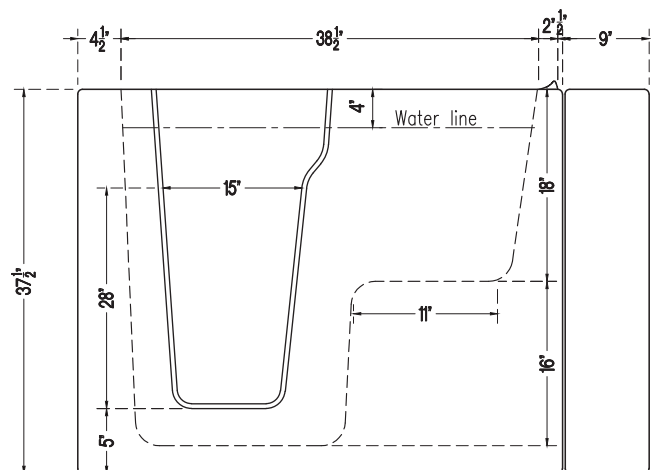

WALK-IN TUBS LA-2848 GROVE

With its unique space-saving design, this compact tub allows for easy maneuverability through narrow doorways and hallways.

- Available in: White and Biscuit
- Marine-Grade Fiberglass & Resin Composite Tub Shell
- High-Gloss, Triple-Coated Gel Coat Finish
- One-Piece, Stainless-Steel Support Frame
- 6 Adjustable Leveling Legs
- Low, 6" Door Threshold
- Ergonomic, Push/Pull Door Handle
- Water-Tight Door Seal
- Inward Swinging Door
- 17" High, Contoured Seat
- Neck Pillow
- **Dimensions:** 28" W x 47 1/2" L x 40" H
- Right or Left Hand Option

***Special Order**



Top View

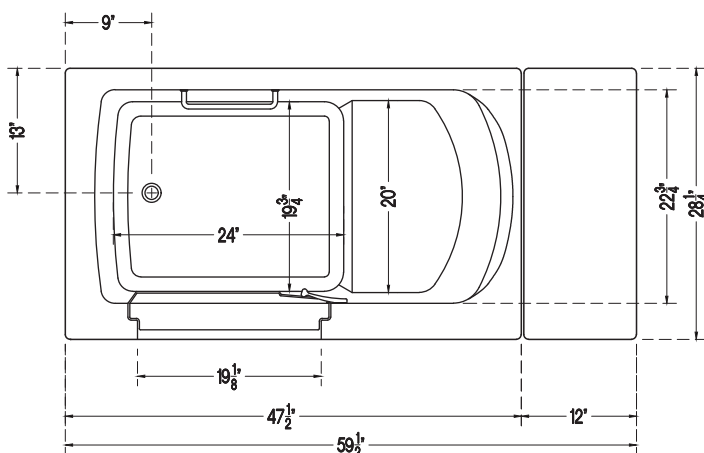

Side View

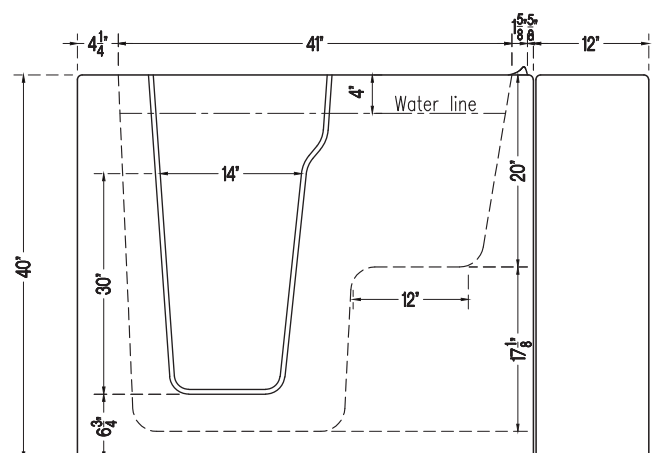

WALK-IN TUBS LA-3052W ZURICH

This tub represents an ambitious balance of accessibility, compactness, and functionality.

- Available in: White and Biscuit
- Marine-Grade Fiberglass & Resin Composite Tub Shell
- High-Gloss, Triple-Coated Gel Coat Finish
- One-Piece, Stainless-Steel Support Frame
- 6 Adjustable Leveling Legs
- Low, 6" Door Threshold
- Ergonomic, Push/Pull Door Handle
- Water-Tight Door Seal
- Outward Swinging Door
- 17" High, ADA-Compliant, Contoured Seat
- Neck Pillow
- **Dimensions:** 29 ³/₄" W x 52" L x 40 ¹/₄" H
- Right or Left Hand Option

***Special Order**



Top View

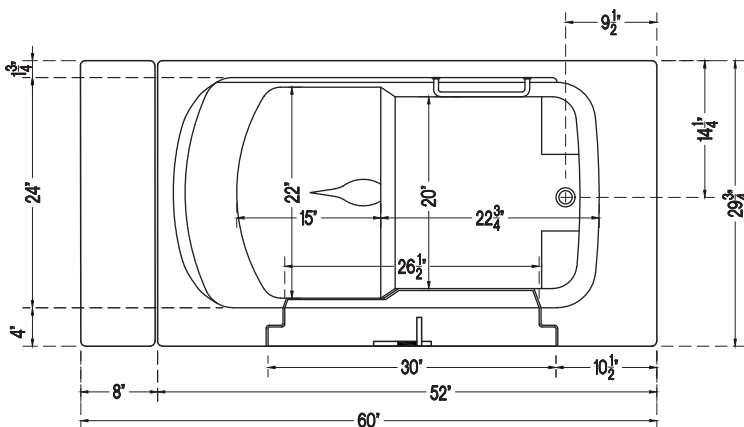

Side View

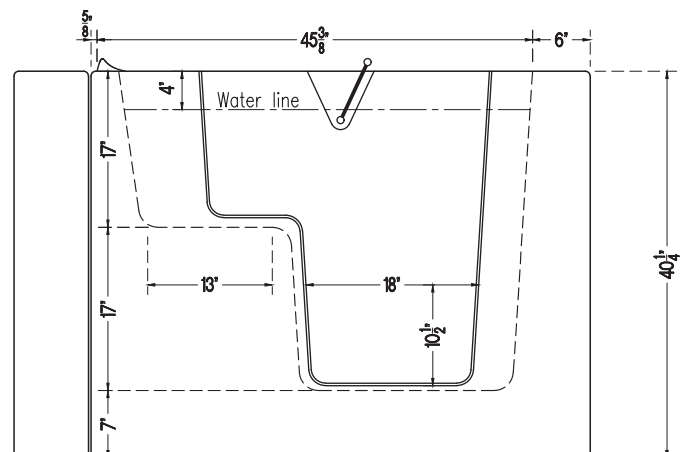

WALK-IN AND WALK-THRU TUB WALK-THRU INSERT

Add safety and convenience to your existing bathtub with this simple insert that converts your tub into a low-barrier shower.

- An affordable solution that is convenient, adds easy access and added safety
- Reduce the possibility of hazardous falls when getting in and out of the tub
- Simple to install, requires no major demolition

· Kit Includes:
Cap, Epoxy and Instruction

· Available in White only

· **Dimensions:**

SMALL - Maximum Rail 4 $\frac{3}{4}$ "
MEDIUM - Maximum Rail 5 $\frac{3}{4}$ "
LARGE - Maximum Rail 7 $\frac{3}{4}$ "

- Walk-Thru Cutting template
SMALL
MEDIUM
LARGE
SET OF ALL 3

- Optional Quicktub accessory converts the unit back to a tub

**NOTE: QuickTub is only available in
SMALL and MEDIUM sizes**



**OPTIONAL "QUICKTUB" CLAMPS IN, CREATES
A TIGHT SEAL AND CONVERTS BACK TO A BATH.**

LIQUID ACCENTS WALK-IN BATHTUB SHOWER CURTAIN

The ideal accessory for your new Walk-in Bathtub Shower Trim Kit.

- Curtain height is specially designed for walk-in bathtubs
- Metal grommets (Rod and rings sold separately)
- Rings available in Brushed Nickel, Stainless Steel and Oil Rubbed Bronze
- Durable semi-obscured, vinyl material
- Can be used with any walk-in tub
- **Dimensions:** 60" x 48"



LA-SHRCUR



RR-B

RR-S

RR-ORB

WALK-IN BATHTUB RAIN SHOWER TRIM KIT

Slide bar hand shower adjusts to optimum bather height.

- Chrome-plated stainless steel construction
- 28" length slider bar range
- 4 sleeve mount brackets. (Two 1.5" long brackets for plumbing from the extension panel - Bath Concepts recommended installation. Plus, two 2.5" long brackets for plumbing from the tub deck.)
- Chrome rain showerhead
- Chrome diverter included
- Hose length = 60"
- Depth: Rain Showerhead to wall distance = 17.5"
- Height from deck top to top of rain shower extension = 42"
- Height from floor to top of rain shower arm = 77"



LA-WIT-ST-C

WALK-IN BATHTUB DECK FAUCET

Optional tub deck faucet kit.

- Standard Setup: Faucets, hand held showerhead and roman tub spout
- Chrome diverter included
- New sleek handles add a more contemporary, yet ergonomic design to our walk-in tub
- Chrome-plated stainless steel construction



LA-WIT-BT-C

DIGITAL THERMOMETER HAND SHOWER

The digital hand-held showerhead features a sleek design and the light changes with temperature variations.

- Wand color indicates water temperature.
Built-in water (hydro) power, no battery, light changes with temperature!
- Water temperature $<90^{\circ}\text{F}$ = BLUE LIGHT
Water temperature $90^{\circ} - 108^{\circ}\text{F}$ = GREEN LIGHT
Water temperature $108^{\circ} - 122^{\circ}\text{F}$ = RED LIGHT
Water temperature $>122^{\circ}\text{F}$ = FLASHING RED LIGHT



**DIGITAL THERMOMETER
HAND SHOWER (OPTIONAL)**

(LA-HHSTEMP-C)

WALK-IN TUB BASEBOARD TRIM

Finish your walk-in tub installation with our color-matched baseboard trim

- Available in White or Biscuit
- **Dimensions:** $59\frac{3}{4}'' \times 4\frac{1}{4}''$



LA-WIBT-BB-?



Bathtub

Drains



BATHTUB DRAINS AND DRAIN ADAPTERS



- **220 1.375-16 DRAIN**
- **301 1.6-16 DRAIN**
- **305 1.865-11.5 DRAIN**
- **309 1.625-14 DRAIN**
- **WIDE FLANGE DRAIN**



BRASS ADAPTER



DRAIN ADAPTER ID KIT

BRASS ADAPTER ORDER INFORMATION:

AD-?

- 1 Converts from 1.6"-16 to 1.865"-11 1/2 - A1 (Green)
- 2 Converts from 1.6"-16 to 1.8"-14 - A2 (Blue)
- 3 Converts from 1.6"-16 to 1.8"-16 - A3 (Red)
- 4 Converts from 1.6"-16 to 1.9"-14 - A4 (Orange)
- 5 Converts from 1.865"- 11 1/2 to 2.11"-16 - A5 (Purple)
- 6 Converts from 1.865"- 11 1/2 to 2.30"-11 1/2 - A6 (Pink)
- 7 Converts from 1.6"-16 to 1.735"-16 - A7 (Lt. Blue)
- 8 Converts from 1.6"-16 to 1.865"-16- A8 (Lt. Green)
- 9 Converts from 1.6"-16 to 1.75"-12 - A9 (Brown)
- 10 Converts from 1.6"-16 to 1.865"-14 - A10 (Silver)
- 11 Converts from 1.375"-16 to 1.625"-16 - A11 (White)
- 12 Converts from 1.375"-16 to 1.625"-14 - A12 (Yellow)
- 13 Converts from 1.375"-16 to 1.813"-14 - A13 (Black & White)
- 14 Converts from 1.375"-16 to 1.75"-12 - A14 (Black)
- 15 Converts from 1.865"-11 1/2 to 2.00"-16 - A15 (Red & Blue)
- 16 Converts from 1.375"-16 to 1.6615"-18 - A16 (Orange & Purple)

BATHTUB DRAINS WASTE AND OVERFLOW KITS



**OVERFLOW
(SHOWN IN CHROME)**



**ART FLEX OVERFLOW
TUBE**



OVERFLOW GASKET



BATHTUB DRAIN



OVERFLOW TUBE

OVERFLOW ORDER INFORMATION: (KIT INCLUDES PLATE, CROSSBAR & SCREW)

OF-?

A	Almond
BG	Brushed Gold
BN	Brushed Nickel
C	Chrome
MB	Matte Black
ORB	Oil Rubbed Bronze
P	Polished Brass
W	White

OVERFLOW GASKET ORDER INFORMATION:

OF-GKT

FLEXIBLE WASTE OVERFLOW TUBE

(DR-FLXWASTE-?)

C	Chrome
BG	Brushed Gold
BN	Brushed Nickel
MB	Matte Black
ORB	Oil Rubbed Bronze

305 COMPLETE WASTE ASSEMBLY WITH DRAIN AND OVERFLOW (FOR SPRAY FOAM TUBS) ORDER INFORMATION:

DRWASTEASMBLY-?

A	Almond
BG	Brushed Gold
BN	Brushed Nickel
C	Chrome
MB	Matte Black
O	Oil Rubbed Bronze
P	Polished Brass
W	White

305 COMPLETE WASTE ASSEMBLY WITH DRAIN AND OVERFLOW FOR 19" SOAKER (FOR SPRAY FOAM TUBS) ORDER INFORMATION:

DR-WA-SOAK-?

BN	Brushed Nickel
C	Chrome
MB	Matte Black
ORB	Oil Rubbed Bronze
PB	Polished Brass
W	White



Standard Size Replacement Shower

Bases



STANDARD SIZE ACRYLIC REPLACEMENT SHOWER BASE MATRIX

(All acrylic except where noted)

PRODUCT STYLES	DIMENSIONS	COLORS				
		White	Almond	Biscuit	Gray	Sandbar
SINGLE THRESHOLD SHOWER BASES CENTER DRAIN	32" x 32"	X	X	X	X	X
	36" x 36"	X	X	X	X	X
	48" x 32"	X	X	X	X	X
	48" x 34"	X	X	X	X	X
	60" x 30"	X	X	X	X	X
	60" x 32"	X	X	X	X	X
	60" x 34"	X	X	X	X	X
	60" x 36"	X	X	X	X	X
END DRAIN STANDARD SHOWER BASES	60" x 30" L/R	X	X	X	X	X
	60" x 32" L/R	X	X	X	X	X
SLIP-RESISTANT BOTTOM	60" x 36"	X	X	X	X	X
	60" x 100"	X	X	X	X	X

*Special Order: Gray & Sandbar

STANDARD SIZE ACRYLIC REPLACEMENT SHOWER BASE

In as little as one day, Bath Planet can replace your high-sided tub with an easy access beautiful shower.

- Installer friendly
- All Bath Concepts-manufactured bases are water tested for superior drainage
- Fiberglass reinforced for maximum support and sound deadening
- **Dimensions:** From 30" to 60"

NOTE: All fiberglass-backed shower bases should be set in a bed of mortar

In-stock item.





Custom Acrylic foam-backed Shower

Bases



CUSTOM ACRYLIC FOAM-BACKED SHOWER BASE MATRIX

PRODUCT	WIDTH & HEIGHT	COLORS																					
		White	Almond	Biscuit	Gray	Sandbar	Black	Bianco Travertine	Brecchia (M)	Calcutta Marble	Classic Concrete (M)	Evo (M)	Galena (M)	Lightning (M)	Linen (M)	Madeira Granite	Metapeake (M)	Pompeii Marble	River Rock (M)	Roman Stone (M)	Silver White Marble	Travertine	Tuscany
CUSTOM ACRYLIC FOAM-BACKED SHOWER BASES*	Up to 60" L & Up to 36" W	X	X	X	X	X	X	X	X	X	X	X	X	X	X	X	X	X	X	X	X	X	X
	Oversized Up to 72" L & Up to 48" W	X	X	X	X	X	X	X	X	X	X	X	X	X	X	X	X	X	X	X	X	X	X
	Double Threshold	X	X	X	X	X	X	X	X	X	X	X	X	X	X	X	X	X	X	X	X	X	X
	Low Barrier 60" L x 30" W 60" L x 32" W	X	X	X	X	X	X	X	X	X	X	X	X	X	X	X	X	X	X	X	X	X	X
NEO-ANGLE SHOWER BASES	35" x 35"	X	X	X	X	X																	
	38" x 38"	X	X	X	X	X																	
LOW-BARRIER ACRYLIC SPRAY FOAM BASES	60" x 30" 60" x 32"	Inquire about available sizes and colors. Available in Acrylic and Gel Coat																					

Custom acrylic foam-backed shower bases are special order*

***NOTE:** Not stocked items.



BLACK SHOWER BASES

High-gloss Black bases lend a striking and unique feature to any bathroom.

- Foam reinforced for maximum support and sound deadening
- Constructed from durable ABS-backed acrylic
- Self leveling for easy installation
- Textured floor
- All bases are water tested for superior drainage
- **Dimensions:**
Up to 60" in Length and up to 36" in Width

NOTE: Not a stocked item.



CUSTOM (PREMIUM) FOAM-BACKED SHOWER BASES

In as little as one day, Bath Planet can replace your high-sided tub with an easy access beautiful shower.

- Foam reinforced for maximum support and sound deadening
- Constructed from durable ABS-backed acrylic
- Self leveling for easy installation
- Textured floor
- All bases are water tested for superior drainage
- **Dimensions:**
Up to 60" in Length and up to 36" in Width

NOTE: Not a stocked item.



Available in all colors except Matte White, Grayline, Othello, and London Fog.

COLOR OPTIONS:

White	Calcutta Marble	Pompeii Marble
Almond	Classic Concrete (M)	River Rock (M)
Biscuit	Evo (M)	Roman Stone (M)
Gray	Galena (M)	Silver White Marble
Sandbar	Lightning (M)	Travertine
Black	Linen (M)	Tuscany
Bianco Travertine	Madeira Granite	
Brecchia (M)	Metapeake (M)	

CUSTOM EXTRA LARGE SHOWER BASES

In as little as one day, Bath Planet can replace your high-sided tub with an easy access beautiful shower.

- Foam reinforced for maximum support and sound deadening
- Center drain only
- Constructed from durable ABS-backed acrylic
- Self leveling for easy installation
- Installer Friendly
- All bases are water tested for superior drainage
- **Dimensions:**
Over 60" in Length and over 36" in Width
- Largest size available 72" x 48"

NOTE: Not a stocked item.



COLOR OPTIONS:

White	Calcutta Marble	Pompeii Marble
Almond	Classic Concrete (M)	River Rock (M)
Biscuit	Evo (M)	Roman Stone (M)
Gray	Galena (M)	Silver White Marble
Sandbar	Lightning (M)	Travertine
Black	Linen (M)	Tuscany
Bianco Travertine	Madeira Granite	
Brecchia (M)	Metapeake (M)	

CUSTOM DOUBLE THRESHOLD SPRAY FOAM SHOWER BASE

In as little as one day, Bath Planet can replace your high-sided tub with an easy access beautiful shower.

- Foam reinforced for maximum support and sound deadening
- Center drain only
- Constructed from a durable, high-tech acrylic
- Self leveling for easy installation
- Installer friendly
- All Bath Concepts-manufactured bases are water tested for superior drainage
- **Dimensions:**
Up to 68" in Length and up to 46" in Width
Min: 32"L x 32"W center
Max: 68"L x 46"W center

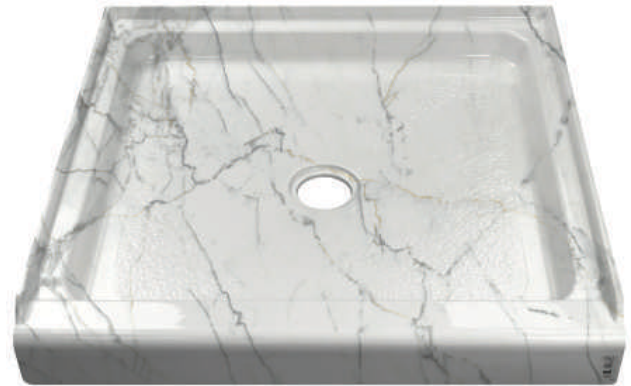

NOTE: Not a stocked item.

COLOR OPTIONS:

White	Calcutta Marble	Pompeii Marble
Almond	Classic Concrete (M)	River Rock (M)
Biscuit	Evo (M)	Roman Stone (M)
Gray	Galena (M)	Silver White Marble
Sandbar	Lightning (M)	Travertine
Black	Linen (M)	Tuscany
Bianco Travertine	Madeira Granite	
Brecchia (M)	Metapeake (M)	

LOW-BARRIER SHOWER BASE

Shower safely while remaining at home with a low-barrier shower base.

- Available in all solid and premium colors
- Molded, one piece acrylic spray foam shower pan
- Available in left end drain and right end drain
- Can be used with optional ramp
- Can accommodate all shower doors
- **Dimensions:** 60x30" and 60x32"
- Optional rubber water dam available



NOTE: *Not a stocked item.*

COLOR OPTIONS:

White	Classic Concrete (M)	Metapeake (M)
Almond	Evo (M)	Pompeii Marble
Biscuit	Galena (M)	River Rock (M)
Gray	Lightning (M)	Roman Stone (M)
Sandbar	Linen (M)	Silver White Marble
Bianco Travertine	Madeira Granite	Travertine
Brecchia (M)		Tuscany
Calcutta Marble		

STANDARD SIZE ACRYLIC REPLACEMENT NEO-ANGLE SHOWER BASE

The Neo-Angle shower fits neatly into corners to save space.

- Spray foam reinforced for maximum support and sound deadening
- Available in White, Almond, Biscuit, Gray, and Sandbar
- Installer friendly
- All bases are water tested for superior drainage
- **Dimensions:** 38" x 38" and 35" x 35"
- Center drain

NOTE: Not a stocked item.



SLIP RESISTANT BOTTOM

A safe and reliable textured pattern that provides a slip-resistant shower floor.

- **Dimensions:**
 1. 59.5" L x 47.75" W x 0.120"
 2. 60" L x 94" W x 0.120" (at additional charge)

NOTE: Not available in black.



COLOR OPTIONS:

White	Classic Concrete (M)	River Rock (M)
Almond	Evo (M)	Roman Stone (M)
Biscuit	Galena (M)	Silver White Marble
Gray	Lightning (M)	Travertine
Sandbar	Linen (M)	Tuscany
Bianco Travertine	Madeira Granite	
Brecchia (M)	Metapeake (M)	
Calcutta Marble	Pompeii Marble	

Acrylic Shower Liner

Bases



ACRYLIC SHOWER LINER BASES MATRIX

PRODUCT STYLES	DIMENSIONS	COLORS				
		White	Almond	Biscuit	Gray	Sandbar
SINGLE THRESHOLD SHOWER BASES	32" x 32"	X	X	X	X	X
	36" x 36"	X	X	X	X	X
	48" x 32"	X	X	X	X	X
	48" x 34"	X	X	X	X	X
	60" x 30"	X	X	X	X	X
	60" x 32"	X	X	X	X	X
	60" x 34"	X	X	X	X	X
	60" x 36"	X	X	X	X	X
CUSTOM THRESHOLD	69" Maximum	X	X	X	X	X



Shower

Drains



SHOWER DRAINS DRAINS

Every Acrylic Replacement Shower Pan will require a new 2" drain.

- All Drains meet the Universal Plumbing Code
- PVC and Brass Drains available
- Standard Sizes means a guaranteed fit every time
- NOT included with shower bases.
Drains must be ordered with each shower base.



REPLACEMENT SHOWER BASE DRAIN



SHOWER PAN DRAIN



2" BRASS REPLACEMENT SHOWER BASE DRAIN (SHOWN IN CHROME)



SNAP-IN DRAIN

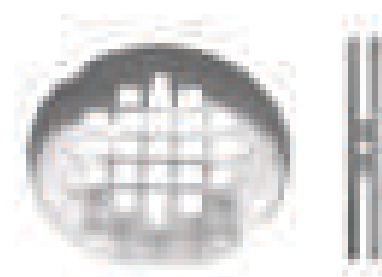

FLAT DRAIN COVER

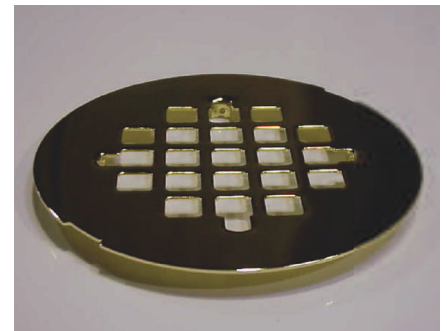

SHOWER DRAIN GRID COVER (SHOWN IN POLISHED BRASS)



1.5" & 2" REPLACEMENT SHOWER BASE DRAIN, SIDE OUTLET

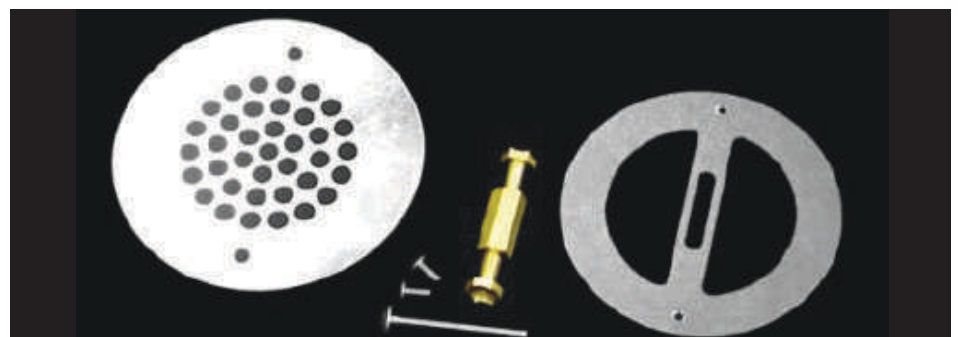

SHOWER BASE LINER DRAIN ASSEMBLY

Acrylic

Walls



ACRYLIC WALLS COLOR MATRIX

PRODUCT STYLES	WIDTH & HEIGHT	COLORS																							
		Grayline & Othello [†]	London Fog	White	Almond	Biscuit	Gray	Sandbar	Matte White (M)	Bianco Travertine	Brecchia (M)	Calcutta Marble	Classic Concrete (M)	Evo (M)	Galena (M)	Lightning (M)	Linen (M)	Madeira Granite	Metapeake (M)	Pompeii Marble	River Rock (M)	Roman Stone (M)	Silver White Marble	Travertine	Tuscany
STOCKED ITEMS																									
SILICONE TUBE COLORS	N/A	W	W	W	S	S	G	S	W	T	T	GT	G	G2	W	G2*	G2*	GR	G2*	G	T	G2*	G2*	S	W
FLAT WALLS	40" x 98.5"	⊗	⊗	✓	✓	✓	✓	✓	✓	✓	✓	✓	✓	✓	✓	✓	✓	✓	✓	✓	✓	✓	✓	✓	✓
	38" x 65"	⊗	⊗	✓	✓	✓	✓	✓	✓	✓	✓	✓	✓	✓	✓	✓	✓	✓	✓	✓	✓	✓	✓	✓	✓
	61" x 85"	⊗	⊗	✓	✓	✓	⊗	⊗	⊗	⊗	⊗	⊗	⊗	⊗	⊗	⊗	⊗	⊗	⊗	⊗	⊗	⊗	⊗	⊗	⊗
	65" x 98.5"	⊗	⊗	✓	✓	✓	✓	✓	✓	✓	✓	✓	✓	✓	✓	✓	✓	✓	✓	✓	✓	✓	✓	✓	✓
	85" x 132"	⊗	⊗	✓	✓	✓	⊗	⊗	⊗	⊗	⊗	⊗	⊗	⊗	⊗	⊗	⊗	⊗	⊗	⊗	⊗	⊗	⊗	⊗	⊗
MESA VERDE	95" x 5"	⊗	⊗	✓	✓	✓	✓	✓	⊗	⊗	⊗	⊗	⊗	⊗	⊗	⊗	⊗	⊗	⊗	⊗	⊗	⊗	⊗	⊗	⊗
PUEBLO	95" x 5"	⊗	⊗	✓	✓	✓	✓	✓	⊗	✓	✓	✓	✓	✓	✓	✓	✓	✓	✓	✓	✓	✓	✓	✓	✓
SANTA FE LISTELLO	80" x 5"	⊗	⊗	✓	✓	✓	✓	✓	⊗	✓	✓	✓	✓	✓	✓	✓	✓	✓	✓	✓	✓	✓	✓	✓	✓
NON-STOCKED ITEMS																									
SIM-TILE WAINSCOT	58" x 97.5"	⊗	⊗	Sim-tile Wainscot are available in all Bath Planet colors except Grayline, Othello, & London Fog.																					
SIM-TILE WALLS	36" x 98" 60" x 98"	⊗	⊗	All Sim-tile Available in all Bath Planet colors except Grayline, Othello, & London Fog.																					
SCALLOPED ACCENT WALL	80" x 98.5"	Scalloped Accent Wall only available in Matte White																							
REVEAL WALLS	65" x 98.5" 40" x 98.5"	Reveal Laser-Etched walls are available in all Bath Planet colors.																							
REVEAL WAINSCOT	58" x 97.5"	Reveal Laser-Etched Wainscot are available in all Bath Planet colors.																							
DECO TRIM	20" x 103"	Deco Trims are available in all Bath Planet colors.																							

SIM-TILE WALL PATTERNS

4" x 4" Tile • 6" x 6" Tile • 8" x 10" Tile • 12" x 12" Slate Tile • Diamond Tile • Subway Tile • Windmill Tile

REVEAL WALLS PATTERNS

3.5" x 16" Chevron • 6" x 24" Fairfield • 6" Hexagonal • 12" x 12" Marazzi • 24" x 6" Milano
3" x 12" Oblong • 12" x 24" Roman Block • 3" x 6" Subway • 4" x 12" Subway

DECO TRIM PATTERNS

2" Hexagon • 1" x 8" Stacked • 2" x 6" Subway

Key

✓ = Product is available in this color ⊗ = Not available (M) = Matte finish 38"x65" = Ceiling Panel †Matte & Gloss Finish

SILICONE COLOR: GR = Granite, GT = Gray Translucent, G = Gray, S = Same as Wall Name, T = Translucent, W = White,
*G2 and G5 = Matching silicone colors. Dealers may also use Gray Translucent for these colors.

LASER-ETCH COLOR SUBSTRATES: Grayline = white face with light gray substrate, London Fog = Gray face with white substrate,
Othello = White face with laser-etched black substrate, Reveal = White substrate; Except for Almond = Almond,
Biscuit = Biscuit, Gray = Gray, Sandbar = Sandbar, & Madeira Granite = Almond

**Colors may appear different than shown. Product & color availability is subject to change.

©Bath Planet, LLC. A division of Bath Concepts, Industries. BPWM 07_25

ACRYLIC WALLS

BATH/SHOWER FLAT WALL SYSTEM SIZES

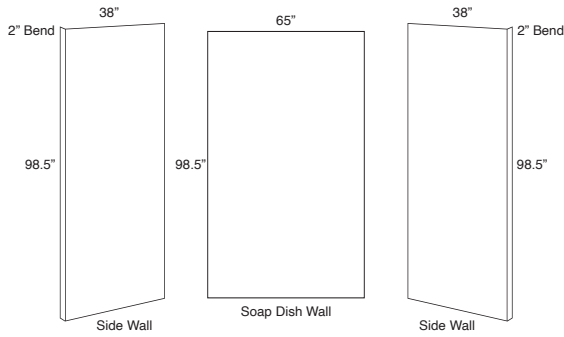

Shower Systems

- (2) Side walls - 38" x 98.5" (2" bend on one side)
- (1) Soap dish wall - 65" x 98.5" flat

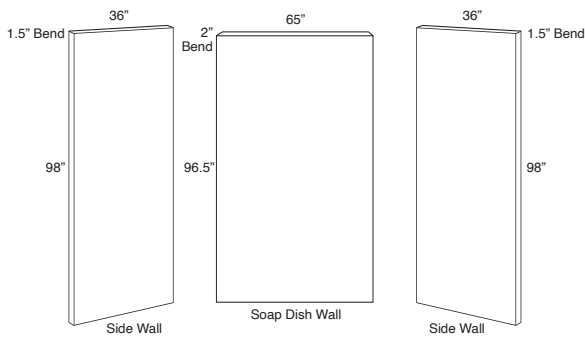

A-Bend Shower System

- (2) Side wall - 36" x 98" (1.5" bend on all four sides)
- (1) Soap dish wall - 65" x 96.5" (2" bend on top)

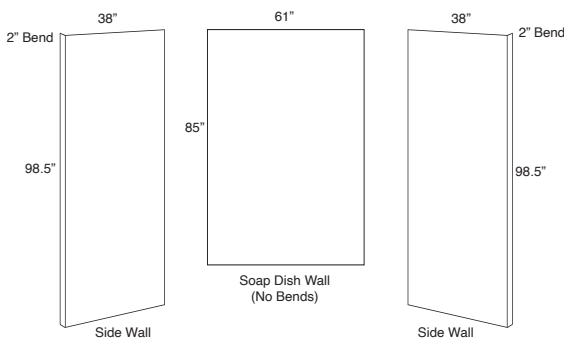

Tub Systems

- (2) Side walls - 38" x 98.5" (2" bend on one side)
- (1) Soap dish wall - 61" x 85" flat

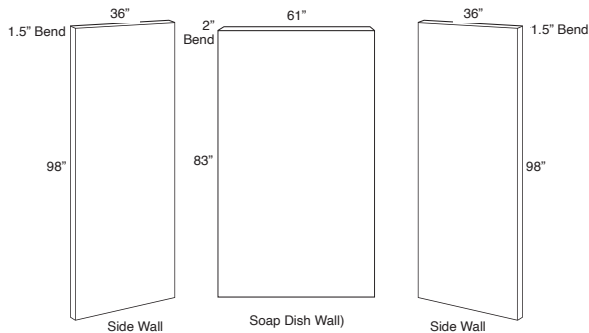

A-Bend System for Tubs

- (2) Side wall - 36" x 98" (1.5" bend on all four sides)
- (1) Soap dish wall - 61" x 83" (2" bend on top)

ACRYLIC WALLS

SHOWER FLAT WALL SYSTEM SIZES

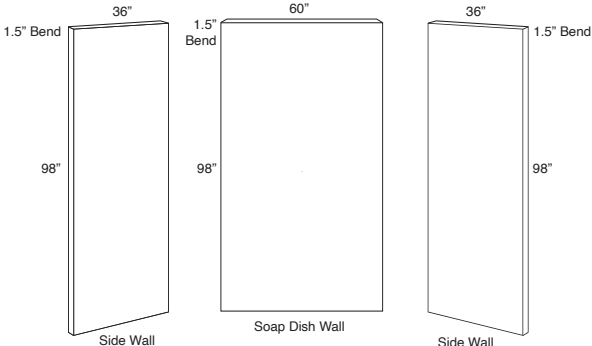

4" x 4" Tile Shower System
 6" x 6" Tile Shower System
 8" x 10" Tile Shower System
 Diamond Tile Shower System
 Subway Tile Shower System
 Windmill Tile Shower System

(2) Side walls - 36" x 98" (1.5" bends on all four sides)
 (1) Soap dish wall - 60" x 98" (1.5" bends on all four sides)

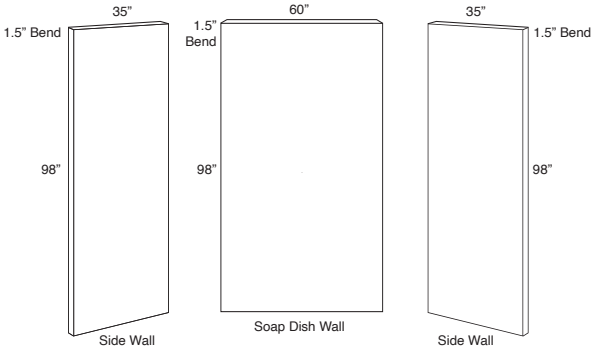

12" x 12" Tile Shower System
 (2) Side walls - 35" x 98" (1.5" bends on all four sides)
 (1) Soap dish wall - 60" x 98" (1.5" bends on all four sides)

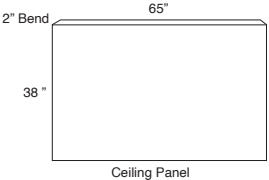

Ceiling Panel
 Ceiling panels are 38" x 65" (2" bend on one side)

ACRYLIC WALLS TUB WALL SYSTEM

Get the chic and clean look of a smooth wall system for your tub.

- Constructed from durable ABS-backed acrylic
- Available in White, Almond and Biscuit
- **Tub Wall Surrounds Dimensions:**
 - (1) - 61"W x 85"H - Flat Wall
 - (2) - 40"W x 98.5"H - Walls with 2" Bend on the 98.5" Side
- **Tub Wall Surrounds with A-Bends Dimensions:**
 - (1) - 61"W x 85"H - with Bend on 61" Side
 - (2) - 36"W x 98"H - Walls with 1.5" Bend on All Four Sides of Panel

NOTE: For ALL Wall Surrounds, it is suggested that (1) Wall Installation Kit and (2) Corner Reinforcements be ordered.

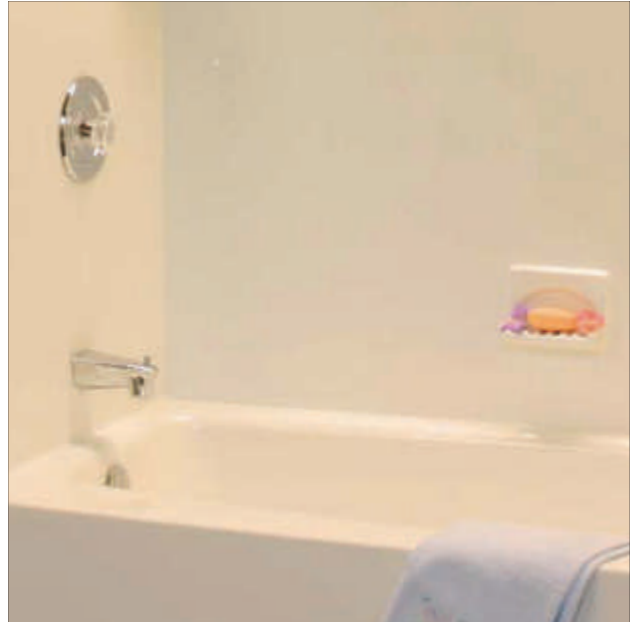

TUB WALL SURROUNDS ORDER INFORMATION:

W-TS-?

W White
A Almond
B Biscuit

TUB WALL SURROUNDS WITH A-BENDS ORDER INFORMATION:

W-TS-AB-?

W White
A Almond
B Biscuit

ACRYLIC WALLS SHOWER WALL SYSTEM

Get the chic and clean look of a smooth wall system for your shower.

- Constructed from durable ABS-backed acrylic
- **Shower Wall Surrounds Dimensions:**
 - (1) - 65" W x 98.5" H - Flat Wall
 - (2) - 40" W x 98.5" H - Walls with 2" Bend on the 98.5" Side

NOTE: For ALL Wall Surrounds, it is suggested that (1) Wall Installation Kit and (2) Corner Reinforcements be ordered.



COLOR OPTIONS:

White	Classic Concrete (M)	Pompeii Marble
Almond	Evo (M)	River Rock (M)
Biscuit	Galena (M)	Roman Stone (M)
Gray	Lightning (M)	Silver White Marble
Sandbar	Linen (M)	Travertine
Bianco Travertine	Madeira Granite	Tuscany
Brecchia (M)	Matte White (M)	
Calcutta Marble	Metapeake (M)	

ACRYLIC WALLS
4" x 4" SIMULATED TILE SYSTEM

The simple and classic 4" x 4"

- Constructed from durable ABS-backed acrylic
- **Simulated Tile Wall Surround Dimensions:**
 - (2) - 36" W x 98" H - Walls
 - (1) - 60" W x 98" H - Wall with a 1.5" Bullnose on all 4 sides of the panel
 - (Walls may be ordered individually as well)

NOTE: Not a Stocked item



6" x 6" SIMULATED TILE SYSTEM

- Constructed from durable ABS-backed acrylic
- **Simulated Tile Wall Surround Dimensions:**
 - (2) - 36" W x 98" H - Walls
 - (1) - 60" W x 98" H - Wall with a 1.5" Bullnose on all 4 sides of the panel
 - (Walls may be ordered individually as well)

NOTE: For ALL Wall Surrounds, it is suggested that (1) Wall Installation Kit and (2) Corner Reinforcements be ordered.

NOTE: For ALL Simulated Tile Walls are formed with a 1.5" bend on all four sides of all panels.

NOTE: Not a Stocked item



COLOR OPTIONS:

White	Classic Concrete (M)	Pompeii Marble
Almond	Evo (M)	River Rock (M)
Biscuit	Galena (M)	Roman Stone (M)
Gray	Lightning (M)	Silver White Marble
Sandbar	Linen (M)	Travertine
Bianco Travertine	Madeira Granite	Tuscany
Brecchia (M)	Matte White (M)	
Calcutta Marble	Metapeake (M)	

ACRYLIC WALLS
8" x 10" SIMULATED TILE SYSTEM

The simple and classic 8" x 10" designer trend look in a wall system.

- Constructed from durable ABS-backed acrylic
- **Simulated Tile Wall Surround Dimensions:**
 - (2) - 36" W x 98" H - Walls
 - (1) - 60" W x 98" H - Wall with a 1.5" Bullnose on all 4 sides of the panel (Walls may be ordered individually as well)

NOTE: Not a Stocked item



12" x 12" SIMULATED TILE SYSTEM

- Constructed from durable ABS-backed acrylic
- Heavily textured
- **Simulated Tile Wall Surround Dimensions:**
 - (2) - 35" W x 98" H - Walls
 - (1) - 60" W x 98" H - Wall with a 1.5" Bullnose on all 4 sides of the panel (Walls may be ordered individually as well)

NOTE: For ALL Wall Surrounds, it is suggested that (1) Wall Installation Kit and (2) Corner Reinforcements be ordered.

NOTE: For ALL Simulated Tile Walls are formed with a 1.5" bend on all four sides of all panels.

NOTE: Not a Stocked item

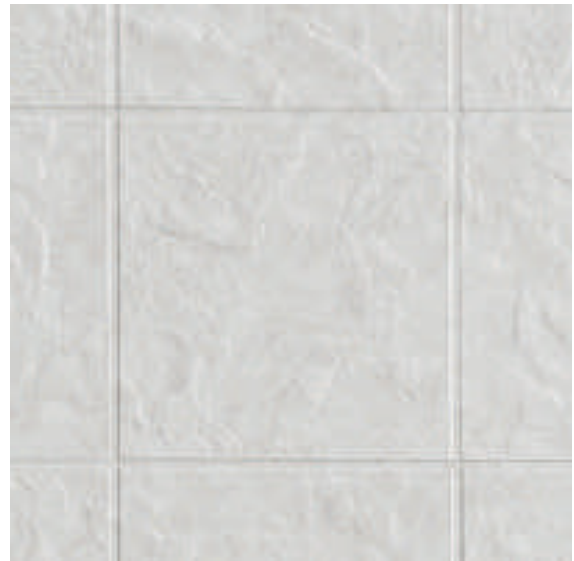

COLOR OPTIONS:

White	Classic Concrete (M)	Pompeii Marble
Almond	Evo (M)	River Rock (M)
Biscuit	Galena (M)	Roman Stone (M)
Gray	Lightning (M)	Silver White Marble
Sandbar	Linen (M)	Travertine
Bianco Travertine	Madeira Granite	Tuscany
Brecchia (M)	Matte White (M)	
Calcutta Marble	Metapeake (M)	

ACRYLIC WALLS
DIAMOND SIMULATED TILE SYSTEM

The simple and classic Diamond designer trend look in a wall system.

- Constructed from durable ABS-backed acrylic
- **Simulated Tile Wall Surround Dimensions:**
 - (2) - 36" W x 98" H - Walls
 - (1) - 60" W x 98" H - Wall with a 1.5" Bullnose on all 4 sides of the panel (Walls may be ordered individually as well)

NOTE: Not a Stocked item



SUBWAY SIMULATED TILE SYSTEM

- Constructed from durable ABS-backed acrylic
- **Simulated Tile Wall Surround Dimensions:**
 - (2) - 36" W x 98" H - Walls
 - (1) - 60" W x 98" H - Wall with a 1.5" Bullnose on all 4 sides of the panel (Walls may be ordered individually as well)

NOTE: For ALL Wall Surrounds, it is suggested that (1) Wall Installation Kit and (2) Corner Reinforcements be ordered.

NOTE: For ALL Simulated Tile Walls are formed with a 1.5" bend on all four sides of all panels.

NOTE: Not a Stocked item



COLOR OPTIONS:

White	Classic Concrete (M)	Pompeii Marble
Almond	Evo (M)	River Rock (M)
Biscuit	Galena (M)	Roman Stone (M)
Gray	Lightning (M)	Silver White Marble
Sandbar	Linen (M)	Travertine
Bianco Travertine	Madeira Granite	Tuscany
Brecchia (M)	Matte White (M)	
Calcutta Marble	Metapeake (M)	

ACRYLIC WALLS
WINDMILL SIMULATED TILE SYSTEM

The simple and classic Windmill designer trend look in a wall system.

- Constructed from durable ABS-backed acrylic
- **Simulated Tile Wall Surround Dimensions:**
 - (2) - 36" W x 98" H - Walls
 - (1) - 60" W x 98" H - Wall with a 1.5" Bullnose on all 4 sides of the panel
(Walls may be ordered individually as well)

NOTE: For ALL Wall Surrounds, it is suggested that (1) Wall Installation Kit and (2) Corner Reinforcements be ordered.

NOTE: For ALL Simulated Tile Walls are formed with a 1.5" bend on all four sides of all panels.

NOTE: Not a Stocked item



COLOR OPTIONS:

White	Classic Concrete (M)	Pompeii Marble
Almond	Evo (M)	River Rock (M)
Biscuit	Galena (M)	Roman Stone (M)
Gray	Lightning (M)	Silver White Marble
Sandbar	Linen (M)	Travertine
Bianco Travertine	Madeira Granite	Tuscany
Brecchia (M)	Matte White (M)	
Calcutta Marble	Metapeake (M)	

ACRYLIC WALLS
FORMED WALL SURROUND - 36" X 98"

For larger areas select the 36" x 98" formed wall surround panels in each Bath Planet color.

- Constructed from durable ABS-backed acrylic

NOTE: For ALL Wall Surrounds, it is suggested that (1) Wall Installation Kit and (2) Corner Reinforcements be ordered.



COLOR OPTIONS:

White	Classic Concrete (M)	Pompeii Marble
Almond	Evo (M)	River Rock (M)
Biscuit	Galena (M)	Roman Stone (M)
Gray	Lightning (M)	Silver White Marble
Sandbar	Linen (M)	Travertine
Bianco Travertine	Madeira Granite	Tuscany
Brecchia (M)	Matte White (M)	
Calcutta Marble	Metapeake (M)	

ACRYLIC WALLS
FLAT WALL SURROUND - 61" X 85"

For larger areas select the 61" x 85" formed wall surround panels in White, Almond and Biscuit.

• Constructed from durable ABS-backed acrylic

Only comes in White, Almond and Biscuit

NOTE: For ALL Wall Surrounds, it is suggested that (1) Wall Installation Kit and (2) Corner Reinforcements be ordered.

NOTE: This is a Stocked item

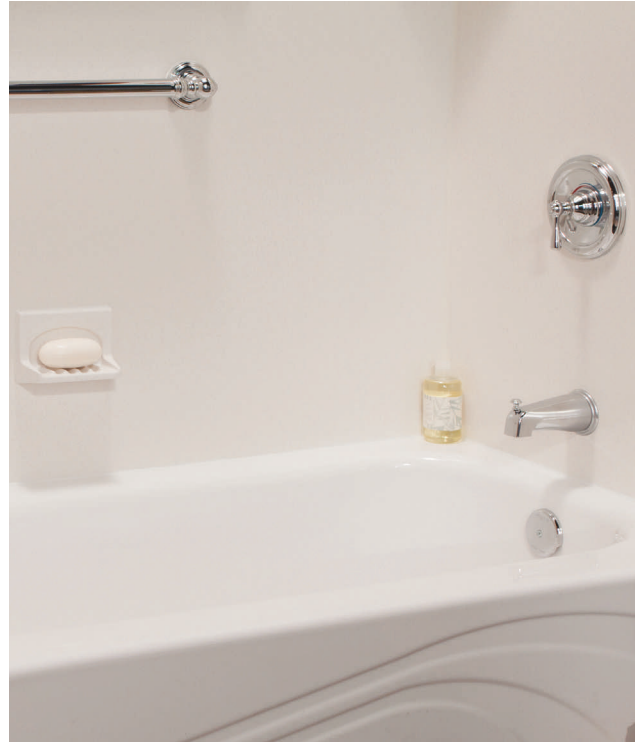

61" x 85" FLAT WALL

61" x 85" (WITH 1 SPECIAL BEND) Flat Wall

61" x 85" (WITH 2 SPECIAL BENDS) Flat Wall

61" x 85" (WITH 3 SPECIAL BENDS) Flat Wall

61" x 85" (WITH 4 SPECIAL BENDS) Flat Wall

ACRYLIC WALLS
FLAT WALL - 65" X 98.5"

For larger areas select the 65" x 98.5" wall surround with bends on each panel in each Bath Planet color.

• Constructed from durable ABS-backed acrylic

NOTE: For ALL Wall Surrounds, it is suggested that (1) Wall Installation Kit and (2) Corner Reinforcements be ordered.

NOTE: Premium Colors Usable pattern is only 62"W on 65" x 98.5" panels.

NOTE: This is a stocked item



65" x 98.5" FLAT WALL

65" x 98.5" (WITH 1 SPECIAL BEND) FLAT WALL

65" x 98.5" (WITH 2 SPECIAL BENDS) FLAT WALL

65" x 98.5" (WITH 3 SPECIAL BENDS) FLAT WALL

65" x 98.5" (WITH 4 SPECIAL BENDS) FLAT WALL

COLOR OPTIONS:

White	Classic Concrete (M)	Pompeii Marble
Almond	Evo (M)	River Rock (M)
Biscuit	Galena (M)	Roman Stone (M)
Gray	Lightning (M)	Silver White Marble
Sandbar	Linen (M)	Travertine
Bianco Travertine	Madeira Granite	Tuscany
Brecchia (M)	Matte White (M)	
Calcutta Marble	Metapeake (M)	

ACRYLIC WALLS CEILING PANELS

Finish the installation with matching ceiling panels.

If you choose you can order a 40" x 98.5" wall with a bend on the 98.5 side and cut to fit on the job site.

- **Dimensions:** 40" W x 65" H
Bend is on the 65" side.
- 38" to the Bend

NOTE: Only available in Smooth.

NOTE: This is a Stocked item

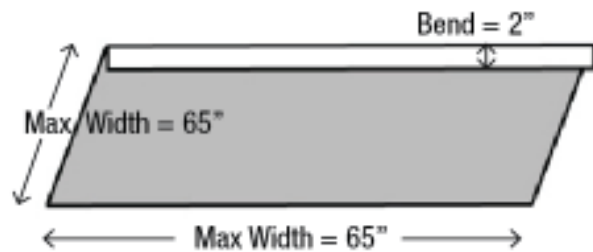

COLOR OPTIONS:

White	Classic Concrete (M)	Pompeii Marble
Almond	Evo (M)	River Rock (M)
Biscuit	Galena (M)	Roman Stone (M)
Gray	Lightning (M)	Silver White Marble
Sandbar	Linen (M)	Travertine
Bianco Travertine	Madeira Granite	Tuscany
Brecchia (M)	Matte White (M)	
Calcutta Marble	Metapeake (M)	

ACRYLIC WALLS
SCALLOPED ACCENT WALL - 60" X 98.5"

For large areas or small accents, this textured matte white wall gives a distinct 3-dimensional feel.

- Constructed from durable ABS-backed acrylic

Only comes in Matte White

NOTE: For ALL Wall Surrounds, it is suggested that (1) Wall Installation Kit and (2) Corner Reinforcements be ordered.



W-60X98.5-SCL-W



Reveal Laser-Etched

Walls



ACRYLIC WALLS REVEAL LASER-ETCHED WALLS

Patented laser-etched wall patterns create the beauty of a real tile wall without the mold and mildew hassle that comes with grouted tile walls.

- Constructed from durable ABS-backed acrylic
- **Shower Wall Surrounds Dimensions:**
 - (1) - 65" W x 98.5" H - Flat Wall
 - (2) - 40" W x 98.5" H - Walls with 2" Bend on the 98.5" Side

NOTE: For ALL Wall Surrounds, it is suggested that (1) Wall Installation Kit and (2) Corner Reinforcements be ordered.



NOTE: Not a Stocked item

REVEAL TILE PATTERNS

COLOR SUBSTRATES:

Reveal = White substrate; Except Almond = Almond, Biscuit = Biscuit, Gray = Gray, Sandbar = Sandbar, Madeira Granite = Almond, Othello = Black, Grayline = Gray.



3.5"x16"
Chevron

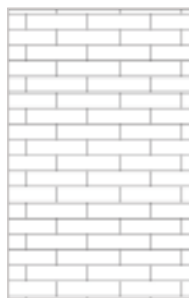

6"x24"
Fairfield



6"
Hexagonal



12"x12"
Marazzi

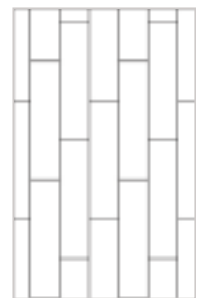

24"x6"
Milano

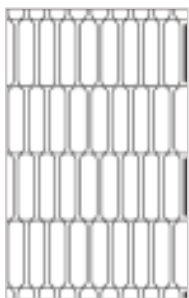

12"x3"
Oblong



12"x24"
Roman Block



3"x6"
Subway

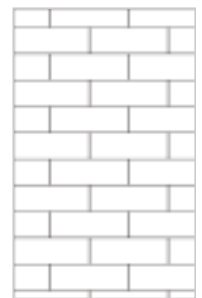

4"x12"
Subway

COLOR OPTIONS:

White
Almond
Biscuit
Gray
Sandbar
Grayline (M&G)
Othello

London Fog
Bianco Travertine
Brecchia (M)
Calcutta Marble
Classic Concrete (M)
Evo (M)
Galena (M)

Lightning (M)
Linen (M)
Madeira Granite
Matte White (M)
Metapeake (M)
Pompeii Marble
River Rock (M)

Roman Stone (M)
Silver White Marble
Travertine
Tuscany

ACRYLIC WALLS
REVEAL OTHELLO LASER-ETCHED WALLS

Patented laser-etched wall patterns create the beauty of a real tile wall without the mold and mildew hassle that comes with grouted tile walls.

- Constructed from durable ABS-backed acrylic
- **Shower Wall Surrounds Dimensions:**
 - (1) - 65" W x 98.5" H - Flat Wall
 - (2) - 40" W x 98.5" H - Walls with 2" Bend on the 98.5" Side

NOTE: For ALL Wall Surrounds, it is suggested that (1) Wall Installation Kit and (2) Corner Reinforcements be ordered.

NOTE: Not a Stocked item

SUBSTRATE:

Othello = White face with laser-etched black substrate. In gloss only. Matte discontinued.



ACRYLIC WALLS
REVEAL GRAYLINE LASER-ETCHED WALLS

Patented laser-etched wall patterns create the beauty of a real tile wall without the mold and mildew hassle that comes with grouted tile walls.

- Constructed from durable ABS-backed acrylic
- **Shower Wall Surrounds Dimensions:**
 - (1) - 65" W x 98.5" H - Flat Wall
 - (2) - 40" W x 98.5" H - Walls with 2" Bend on the 98.5" Side

NOTE: For ALL Wall Surrounds, it is suggested that (1) Wall Installation Kit and (2) Corner Reinforcements be ordered.

NOTE: Not a Stocked item

SUBSTRATE:

Grayline = White face with light gray laser-etched substrate.



ACRYLIC WALLS
REVEAL LONDON FOG LASER-ETCHED WALLS

Patented laser-etched wall patterns create the beauty of a real tile wall without the mold and mildew hassle that comes with grouted tile walls.

- Constructed from durable ABS-backed acrylic
- **Shower Wall Surrounds Dimensions:**
 - (1) - 65" W x 98.5" H - Flat Wall
 - (2) - 40" W x 98.5" H - Walls with 2" Bend on the 98.5" Side

NOTE: For ALL Wall Surrounds, it is suggested that (1) Wall Installation Kit and (2) Corner Reinforcements be ordered.

NOTE: Not a Stocked item

SUBSTRATE:

London Fog = Gray face white laser-etched substrate.



Wainscot and

Trims



LASER ETCHED DECO TRIM

Patented laser-etched wall patterns create the beauty of a real tile wall designed for a final accent to a wall system.

- Constructed from durable ABS-backed acrylic
- Comes in three patterns:
 - 1"x8" Stacked
 - 2"x6" Subway
 - 2" Hexagon
- **Dimensions:** 20"W x 103" H flat (no bends)
- Comes in all colors including Grayline, Othello & London Fog

NOTE: *Not a stocked item.*

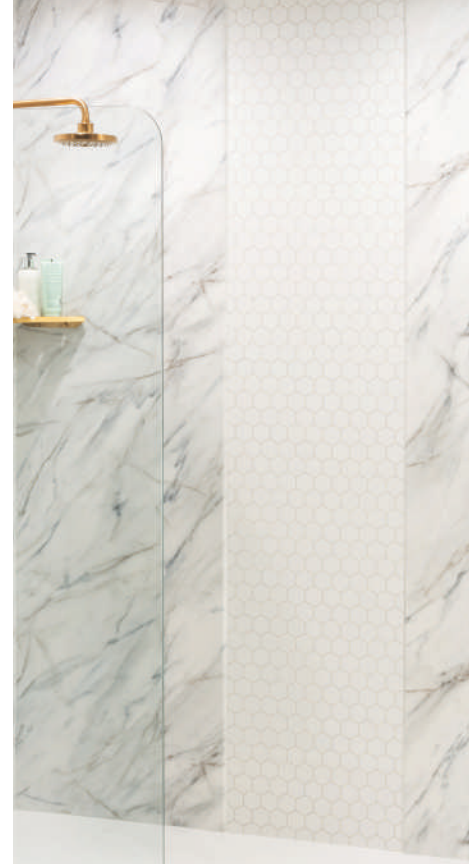

1"x8" Stacked



2"x6" Subway



2" Hexagon

COLOR OPTIONS:

White
Almond
Biscuit
Gray
Sandbar
Grayline (M&G)
Othello

London Fog
Bianco Travertine
Brecchia (M)
Calcutta Marble
Classic Concrete (M)
Evo (M)
Galena (M)

Lightning (M)
Linen (M)
Madeira Granite
Matte White (M)
Metapeake (M)
Pompeii Marble
River Rock (M)

Roman Stone (M)
Silver White Marble
Travertine
Tuscany

WAINSCOT BEAD BOARD, TRIM & BASEBOARD

Tastefully protects your walls from knocks and splashes, wainscot bead board is also an eye-pleasing design element.

- Traditional beaded design
- Constructed from durable ABS-backed acrylic
- **Dimensions:**
 - Walls: 96"W x 58"H
 - Seam: 1.5"W x 58"H
 - Outside Corner: 2.25"W x 58"H
 - Inside Corner: 2.5"W x 58"H
- Integrated chair rail, one piece panel.

NOTE: Not a stocked item.



BASEBOARD TRIM

- Compliments beadboard, wainscot
- **Dimensions:** 5" x 96"
- Glues to the wall with Supertach
- Corners can be forty fived with a miter saw



BASEBOARD TRIM

COLOR OPTIONS:

White	Classic Concrete (M)	River Rock (M)
Almond	Evo (M)	Roman Stone (M)
Biscuit	Galena (M)	Silver White Marble
Gray	Lightning (M)	Travertine
Sandbar	Linen (M)	Tuscany
Bianco Travertine	Madeira Granite	
Brecchia (M)	Metapeake (M)	
Calcutta Marble	Pompeii Marble	

MID-WALL TRIMS

Add the final touch of elegance and design with this contemporary pattern.

- Smooth ceramic-like finish
- Constructed from durable ABS-backed acrylic
- Great for extending walls vertically
- Can be used as decorative mid-wall trim or capping trim
- **Dimensions:**
 - Mesa Verde: 95"L x 5"W with (2) 1.5" flanges
 - Pueblo: 95"L x 5"W with (2) 1.5" flanges
 - Santa Fe Listello: 80"L x 5"W with (2) 1.5" flanges
- Santa Fe Listello available as a two pack, Mesa Verde & Pueblo available as a singular trim



MESA VERDE TRIM



PUEBLO TRIM



SANTA FE LISTELLO TRIM

COLOR OPTIONS: REFER TO THE WALL MATRIX ON PAGE 50

Acrylic

Accessories



ACCESSORIES AND TRIM MATRIX

PRODUCT STYLES	COLORS																						
	White	Almond	Biscuit	Gray	Sandbar	Matte White (M)	Bianco Travertine	Brecchia (M)	Calcutta Marble	Classic Concrete (M)	Evo (M)	Galena (M)	Lightning (M)	Linen (M)	Madeira Granite	Metapeake (M)	Pompeii Marble	River Rock (M)	Roman Stone (M)	Silver White Marble	Travertine	Tuscany	
SINGLE TIER SHELF	X	X	X	X	X	X	X	X	X	X	X	X	X	X	X	X	X	X	X	X	X	X	X
FLUSH MOUNT SOAP DISH	X	X	X	X	X		X	X	X	X	X	X	X	X	X	X	X	X	X	X	X	X	X
FOUR-SHELF CORNER CADDY	X	X	X	X	X		X	X	X	X	X	X	X	X	X	X	X	X	X	X	X	X	X
TOWER CADDY W/SHAVING STAND	X	X	X	X			X	X	X	X	X	X	X	X	X	X	X	X	X	X	X	X	X
BENCH SEAT	X	X	X	X	X		X	X	X	X	X	X	X	X	X	X	X	X	X	X	X	X	X
HEXAGON CORNER SEAT	X	X	X	X	X		X	X	X	X	X	X	X	X	X	X	X	X	X	X	X	X	X
WINDOW KIT	X	X	X	X	X		X	X	X	X	X	X	X	X	X	X	X	X	X	X	X	X	X
HOLE CAPS	X	X	X	X	X		X	X	X	X	X	X	X	X	X	X	X	X	X	X	X	X	X
KNEE WALL CAP TRIM - 1/2" THICK	X	X	X																				
KNEE WALL CAP TRIM - 3/4" THICK	X	X	X	X	X		X	X	X	X	X	X	X	X	X	X	X	X	X	X	X	X	X

FLUSH MOUNT SOAP DISH

Traditional and timeless, the flush mount soap dish is the perfect accessory.

- Installation tip: No need to cut holes in the soap dish wall
- Can be placed at any desired location within the bath enclosure
- Constructed from durable ABS-backed acrylic
- **Dimensions:** 6.875" W x 2.75" D x 5" H
- Available in all wall colors

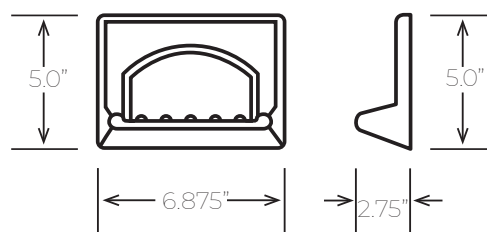

COLOR OPTIONS:

White	Classic Concrete (M)	River Rock (M)
Almond	Evo (M)	Roman Stone (M)
Biscuit	Galena (M)	Silver White Marble
Gray	Lightning (M)	Travertine
Sandbar	Linen (M)	Tuscany
Bianco Travertine	Madeira Granite	
Brecchia (M)	Metapeake (M)	
Calcutta Marble	Pompeii Marble	

SINGLE TIER SHELF

Display all the essential extras that make the bathing experience complete.

- Can be easily installed at any desired height
- Add as many as you like to suit your needs
- Constructed from durable ABS-backed acrylic
- **Dimensions:** 12.75"W x 1.75"H x 9" D
- Comes with bracket and adhesive

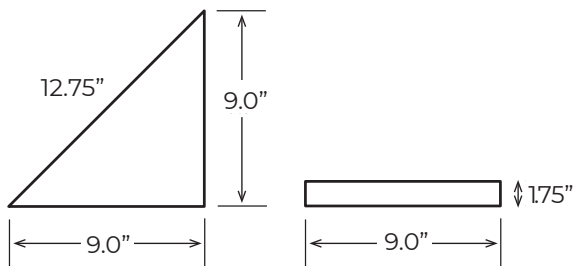

COLOR OPTIONS:

White	Classic Concrete (M)	River Rock (M)
Almond	Evo (M)	Roman Stone (M)
Biscuit	Galena (M)	Silver White Marble
Gray	Lightning (M)	Travertine
Sandbar	Linen (M)	Tuscany
Bianco Travertine	Madeira Granite	
Brecchia (M)	Metapeake (M)	
Calcutta Marble	Pompeii Marble	

4-SHELF CORNER CADDY

Our 4-Shelf Caddy provides the optimal level of storage for your entire family's bath needs.

- Can be easily installed at any desired height
- Can be used over a tub or shower
- Constructed from DR-ABS-backed acrylic
- Contains two ribbed shelves with drainage channels and two smooth shelves
- **Dimensions:** 9.5" W x 35" H x 7" D

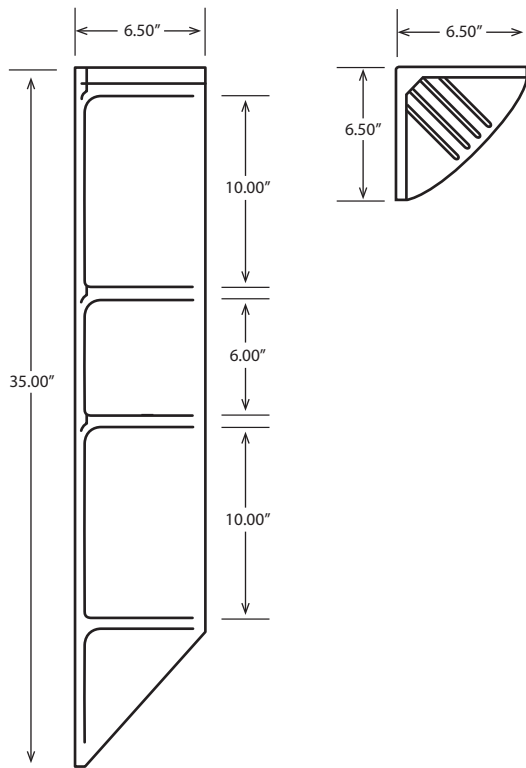

COLOR OPTIONS:

White
Almond
Biscuit
Sandbar
Bianco Travertine
Brecchia (M)
Calcutta Marble
Classic Concrete (M)

Evo (M)
Galena (M)
Lightning (M)
Linen (M)
Madeira Granite
Metapeake (M)
Pompeii Marble
River Rock (M)

Roman Stone (M)
Silver White Marble
Travertine
Tuscany

TOWER CADDY WITH SHAVING STAND

Our Tower Caddy provides the optimal level of storage for your entire family's bathing needs with an added shaving stand.

- Can be used over a tub or shower
- Built-in shaving stand for added comfort
- Constructed from durable ABS-backed acrylic
- Great for extending walls
- 3 smooth shelves
- 1 shelf with drip channels
- Finished top edge for 3/4 systems
- Dimensions: 9.75" W x 98.5" H x 7"D

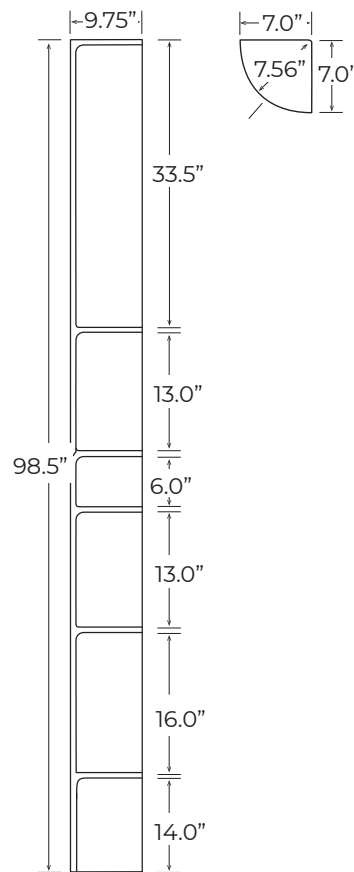

COLOR OPTIONS:

White	Evo (M)	Roman Stone (M)
Almond	Galena (M)	Silver White Marble
Biscuit	Lightning (M)	Travertine
Gray	Linen (M)	Tuscany
Bianco Travertine	Madeira Granite	
Brecchia (M)	Metapeake (M)	
Calcutta Marble	Pompeii Marble	
Classic Concrete (M)	River Rock (M)	

WINDOW KIT

A classic design that blends with any setting providing a beautiful window treatment option.

- Contains a contemporary and decorative window trim
- Encases the window in maintenance-free acrylic
- Dimensions: 8" W x 2" Bend
- Each kit includes: Four pieces that are 6" W x 51" L

NOTE: *Cannot be used to trim out any round window.*



HOLE CAPS

- Constructed from durable ABS-backed acrylic
- Paintable surface on underside
- Available in 4" and 6" in all of the Bath Planet colors to match the shower walls **except**; *Grayline, London Fog, Othello & Matte White.*



COLOR OPTIONS:

White	Classic Concrete (M)	River Rock (M)
Almond	Evo (M)	Roman Stone (M)
Biscuit	Galena (M)	Silver White Marble
Gray	Lightning (M)	Travertine
Sandbar	Linen (M)	Tuscany
Bianco Travertine	Madeira Granite	
Brecchia (M)	Metapeake (M)	
Calcutta Marble	Pompeii Marble	

ACRYLIC KNEE WALL LEDGE CAP

The acrylic knee wall cap can mount to any structurally sound substrate.

- Paintable surface on underside
- Reinforced backing
- Constructed from durable ABS-backed acrylic
- Sizes:
 - 1/2" x 10" x 60"
 - 1/2" x 6" x 40"
 - 1/2" x 6" x 60"
 - 3/4" x 6" x 40"
 - 3/4" x 6" x 72"
- Limited Lifetime Warranty



COLOR OPTIONS: *The 1/2" thick models only come in White, Almond & Biscuit

White	Classic Concrete (M)	River Rock (M)
Almond	Evo (M)	Roman Stone (M)
Biscuit	Galena (M)	Silver White Marble
Gray	Lightning (M)	Travertine
Sandbar	Linen (M)	Tuscany
Bianco Travertine	Madeira Granite	
Brecchia (M)	Metapeake (M)	
Calcutta Marble	Pompeii Marble	

TUB CAP TRIM

Finish off the look and enhance the flow of your bathroom with the tub cap trim.

- Acrylic trim piece used to join tub liner skirt with a panel on a two-wall tub
- Original Bath Planet design
- Constructed from durable ABS-backed acrylic
- Available in White, Almond, Biscuit, Gray and Sandbar
- **Dimensions:** 18" x 4.25"



COLOR OPTIONS:

White
Almond

Biscuit
Gray

Sandbar



Metal Fixtures and

Accessories



LIQUID ACCENTS - METAL CORNER SHELF

Single tier, stainless steel, corner shelf with grates modernizes any shower system.

- Made of sturdy, rust-resistant 304 stainless steel
- Designed to fit any size wall
- Available in Brushed Gold, Brushed Nickel, Chrome, Matte Black and Oil Rubbed Bronze
- **Dimensions:** 9" x 9" x 12"



LIQUID ACCENTS - CORNER GRAB BAR/SHELF

- Made of sturdy, rust-resistant 304 stainless steel
- Designed to fit any size wall
- Available in Brushed Gold, Brushed Nickel, Chrome, Matte Black and Oil Rubbed Bronze
- **Dimensions:** 10" x 10" (Shelf dimensions: 7" x 7")
- ADA Compliant



LIQUID ACCENTS - 18" SLOTTED RECTANGULAR SHELF

Organize the bathroom area with these smart, space-saving shelving options.

- Made of sturdy, rust-resistant metal
- Designed to fit any size wall
- Available in Brushed Gold, Brushed Nickel, Chrome, Matte Black and Oil Rubbed Bronze
- **Dimensions:** 18" x 2.75" high (depth is 4.5")



LIQUID ACCENTS - SLOTTED CORNER SHELF

- Made of sturdy, rust-resistant metal
- Designed to fit any size wall
- Available in Brushed Gold, Brushed Nickel, Chrome, Matte Black and Oil Rubbed Bronze
- **Dimensions:** 8.75" x 2.75"



LIQUID ACCENTS - METAL FOOT REST

Stainless steel shower foot rest is a safe option for your shower, while matching your fixtures

- Made of sturdy, rust-resistant 304 stainless steel
- Four rubber, slip-resistant O-rings for better grip
- Available in Brushed Gold, Brushed Nickel, Chrome, Matte Black and Oil Rubbed Bronze
- 13.25" long, 1" diameter
- Can customize the height
- Easy to install



LA-SFR-?

LIQUID ACCENTS - 24" X 12" NICHE SHELF

A versatile storage solution with handy divider.

- Available in Gray, Matte Black, Stainless Steel and White
- Can be installed horizontally or vertically
- For use inside or outside the wet area
- **Dimensions:** 24" x 12"



LA-NICHE-?

MOEN®

MOEN VERSO™ BRAND MAGNETIX REMOVEABLE SHOWERHEAD

The Verso showerheads include Moen's new Infinity Dial technology that allows users to select several options with continuous pressure. Users slide the dial to blend sprays and pressure to their liking. It's a three-in-one design, enabling the two showerheads to run at the same time or separately.

- Chrome, Brushed Nickel & Matte Black
- 7" Diameter showerhead
- Eight total spray settings
- 1.75 gpm max, CA compliant
- Can customize the height
- 72" Metal Hose



This aromatherapy hand shower is equipped with INLY technology, which infuses essential oils directly into your shower water. Allows you to control the dilution rate. For use with INLY capsules only (sold separately).

- Chrome & Brushed Nickel
- 1/2" Connection Size (IPS)
- 6-function showerhead
- 1.75 gpm max, CA compliant



INLY capsules infuse essential oils and spa-inspired fragrances. (sold in packs of 5)



ENERGETIC MORNING

SWEET MORNING

TROPICAL DAY

ZEN TIME



FIXTURES AND ACCESSORIES / LIQUID ACCENTS
KENSINGTON SHOWERHEAD & MIXER VALVE & TUB KITS

Liquid Accents Kensington showerhead & mixer valve trim.

- Traditional style
- Available in Chrome, Brushed Nickel, Matte Black and Oil Rubbed Bronze



FIXTURES AND ACCESSORIES / LIQUID ACCENTS
SEVILLE SHOWERHEAD, MIXER VALVE & TUB KITS

Liquid Accents Seville showerhead,
mixer valve & tub kit.

- Tub & shower trim
- Available in Chrome, Brushed Nickel, Matte Black
and Oil Rubbed Bronze



FIXTURES AND ACCESSORIES / LIQUID ACCENTS
SIERRA SERIES SHOWERHEAD, MIXER VALVE & TUB KITS

Liquid Accents Sierra Showerhead, Tub Kit & mixer valve trim.

- 2.5 GPM (Gallons Per Minute)
- Available in Polished Chrome, Brushed Nickel, Oil Rubbed Bronze and Matte Black
- 4-Function showerhead
 - Combination
 - Full spray
 - Invigorating spray
 - Targeted massage



THE LIQUID ACCENTS VALVE
Pressure-balanced valve helps maintain water temperature. Meets or exceeds plumbing codes. Built-in shut-off with single standardized cartridge design.

FIXTURES AND ACCESSORIES / LIQUID ACCENTS
SIERRA SERIES SHOWERHEAD & MIXER VALVE

Liquid Accents Sierra Showerhead & mixer valve trim.

- 2.5 GPM (Gallons Per Minute)
- Available in Polished Chrome, Brushed Nickel, Matte Black and Oil Rubbed Bronze
- 4-Function showerhead
 - Combination
 - Full spray
 - Invigorating spray
 - Targeted massage

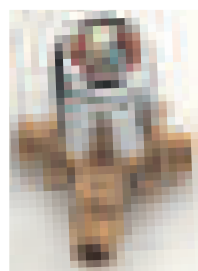

THE LIQUID ACCENTS VALVE
Pressure-balanced valve helps maintain water temperature. Meets or exceeds plumbing codes. Built-in shut-off with single standardized cartridge design.

FIXTURES AND ACCESSORIES / LIQUID ACCENTS
RAIN SHOWERHEAD

Relax under this beautiful, stylish rain showerhead. A 13" "S" arm moves the rain showerhead away from the wall.

- 8" Head
- 13" "S" shower arm
- 90 clog-free nozzles
- 2.5 GPM (Gallons Per Minute)
- Available in Polished Chrome, Brushed Nickel, Oil Rubbed Bronze and Matte Black



FIXTURES AND ACCESSORIES / LIQUID ACCENTS
**HAND-HELD SHOWERHEAD, WALL MOUNT &
DIVERTER VALVE**

This adjustable mount attaches the hand-held showerhead to the wall when a slider bar is not used.

- Available in Polished Chrome, Brushed Nickel and Oil Rubbed Bronze
- 59" hose and shower arm bracket.
- 2.5 GPM (Gallons Per Minute)
- Available in Polished Chrome, Brushed Nickel and Oil Rubbed Bronze
- 4-Function showerhead
 - Combination
 - Full spray
 - Invigorating spray
 - Targeted massage

Order a diverter valve to move water to the hand-held showerhead.

- .5" female inlet and .5" male outlet by .5" hose outlet

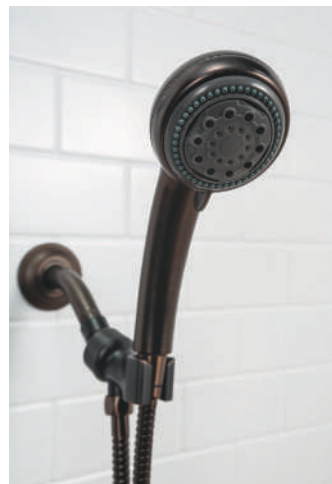

**HAND HELD Showerhead
ORDER INFORMATION:**

LA-HHS01-?

**WALL MOUNT BRACKET
ORDER INFORMATION:**

LA-ADJBRK-?

**DIVERTER VALVE
ORDER INFORMATION:**

LA-DIV-?

FIXTURES AND ACCESSORIES / LIQUID ACCENTS SLIDER BAR

Switch conveniently from standard showerhead to hand-held with this slider bar.

- Available in Polished Brushed Nickel, Chrome, Matte Black and Oil Rubbed Bronze
- Includes hook to hold handheld showerhead
- **Dimensions:** 26"L



LA-SB01-?

ROUND VALVE GRAB BAR

- Mounts to shower wall
- Available in Brushed Gold, Brushed Nickel, Chrome and Oil Rubbed Bronze
- Position around mixer
- Provides extra support while not institutional-looking
- ADA Compliant
- 560 lbs. of pressure



GB-V12-?

FIXTURES AND ACCESSORIES / LIQUID ACCENTS DESIGNER GRAB BARS

Distinctively stylish and easy-to-install, Liquid Accents grab bars include the following features:

- Available in 12", 18", 24" and 36" sizes
- Available in Brushed Gold, Brushed Nickel, Chrome, Matte Black and Oil Rubbed Bronze (36" size offered in Chrome, Brushed Nickel, Oil Rubbed Bronze only)
- Made of sturdy, steel construction*
- More cost-effective price
- ADA Compliant
- Can be installed horizontally, vertically or diagonally
- Lifetime warranty on finish

*Holds up to 500 lbs. Liquid Accents grab bars meet or exceed the applicable requirements of the following standards:
ANSI A117.1, ASTM F446, CSA B45, CSA B651.

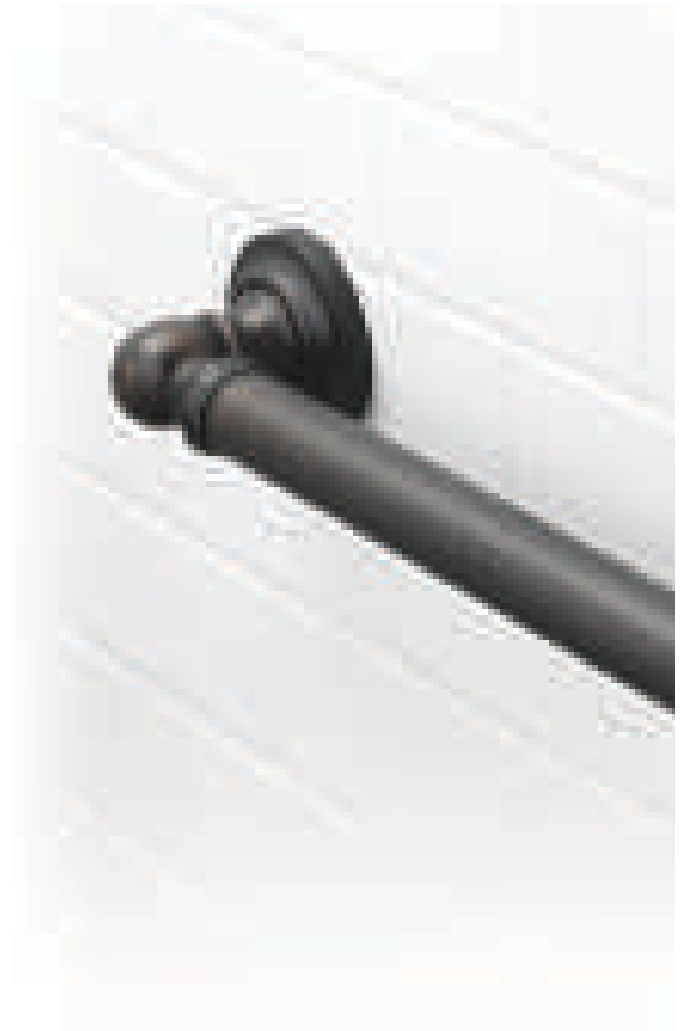

Kensington Grab Bars



Seville Grab Bars

Complement the look of your new bath or shower with these beautiful fixtures from Moen.

- Available in Polished Chrome, Brushed Nickel and Oil Rubbed Bronze

Note: Matte Black and Brushed Gold are optional on some models

- All brass construction
- Includes mounting hardware
- Rust resistant fixtures



BELFIELD FAUCET

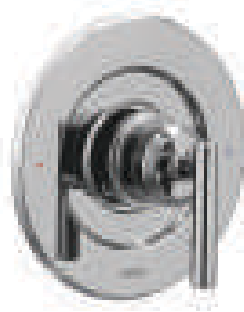

GIBSON CHROME TRIM KIT



VOSS BRUSHED NICKEL TOWEL RING



EVA TOWEL BAR



DARTMOOR TUB AND SHOWER KIT



EVA ROBE HOOK



BRANTFORD TANK LEVER

*This is a sampling. We also offer other Moen product lines. Contact your customer success representative for more information.

Add style and sophistication to your new bath or shower with these fixtures from Delta.

- Available in Polished Chrome, Brushed Nickel and Oil Rubbed Bronze

Note: Matte Black and Brushed Gold are optional on some models



LAHARA SHOWERHEAD, MIXER VALVE & TUB KIT



ASHLYN PAPER HOLDER



ARA ROBE HOOK



ADA GRAB BAR



LINDEN SHOWERHEAD, MIXER VALVE & TUB KIT



TRINSIC TOWEL RING

*This is a sampling. We also offer other Delta product lines. Contact your customer success representative for more information.

Showerhead, mixer valve trim and tub kit.

- Moen kits in designer Chateau (Chrome only), Kingsley and Eva trims



CHATEAU

EVA

THE MOENTROL VALVE
 Pressure-balanced valve helps maintain water temperature. Meets or exceeds plumbing codes. Built-in shut-off with single standardized cartridge design.

THE MOEN POSI-TEMP SWEAT VALVE
 Pressure-balanced valve helps maintain water temperature. Meets or exceeds plumbing codes. Built-in shut-off with single standardized cartridge design.

CHATEAU SHOWERHEAD, MIXER AND TUB KITS ORDER INFORMATION:

MTL183-?

C Chrome

EVA SHOWERHEAD, MIXER AND TUB KITS ORDER INFORMATION:

MT-2133-?

C Chrome
 BN Brushed Nickel
 ORB Oil Rubbed Bronze

MOENTROL VALVE ORDER INFORMATION:

MOE-62370

Moentrol Sweat Valve (No Trim)

MOENTROL VALVE & TRIM ORDER INFORMATION:

SV-3189

Moentrol Valve & Trim - Chrome

DESIGNER ROMAN WALK-IN TUB FAUCETS

Add a beautifully finished Roman tub faucet from Moen. For use with Walk-In Tubs.

- Available in Polished Chrome, Brushed Nickel and Oil Rubbed Bronze
- All brass construction
- ADA compliant handle



KINGSLEY HIGH ARC ROMAN TUB FAUCET



KINGSLEY HIGH ARC ROMAN TUB FAUCET WITH HAND SHOWER

CHATEAU TWO HANDLE HIGH ARC ROMAN TUB FAUCET WITH 4792 VALVE ORDER INFORMATION:

MT920-?

BN Brushed Nickel
C Chrome

KINGSLEY TWO HANDLE HIGH ARC ROMAN TUB FAUCET WITH HAND SHOWER & 9792 VALVE ORDER INFORMATION:

MT922-?

BN Brushed Nickel
C Chrome
ORB Oil Rubbed Bronze

BRANTFORD TWO HANDLE WALK-IN TUB FAUCET WITH HAND SHOWER & 9792 VALVE ORDER INFORMATION:

MT924-?

BN Brushed Nickel
C Chrome
ORB Oil Rubbed Bronze



BRANTFORD HIGH ARC FAUCET WITH HAND SHOWER

ADJUSTABLE CURVED SHOWER ROD

The curved shower rod is a beautiful bathroom storage option with a classic design, blending with any setting.

- Provides up to 7 inches of added interior space and 25% more elbow room than conventional rods
- 100% stainless steel construction (rod, flanges and covers)
- Available in Polished Brass, Brushed Nickel, Oil Rubbed Bronze, Stainless Steel and White
- Secure mounting posts allow for multi-screw installation
- Unique flange pivots 180 degrees
- Complete mounting hardware included for drywall, wood and tile
- Brings curtain back at the corners preventing water from leaking out of the bath enclosure
- **Dimensions:**
Fits 54", 60", 66" and 72" applications



RR-?

5' CURVED SHOWER ROD ORDER INFORMATION:

SR-5-?

B Polished Brass Rod
BN Brushed Nickel Rod
ORB Oil Rubbed Bronze Rod
S Stainless Steel Rod
W White Rod

6' CURVED SHOWER ROD ORDER INFORMATION:

SR-6-?

BN Brushed Nickel Rod
S Stainless Steel Rod

STRAIGHT AND ADJUSTABLE SHOWER RODS

The straight shower rod provides a clean line and matches your other fixtures.

- 100% stainless steel construction (rod, flanges and covers)
- Secure mounting posts allow for multi-screw installation
- Complete mounting hardware included for drywall, wood and tile
- **Dimensions:**
Fits 60" and 72" applications



The tension shower rod provides a no-hassle, decorative element for your bath.

- 100% stainless steel construction (rod, flanges and covers)
- Available in Chrome only
- No drill, easy installation
- Adjustable length of 57" to 60"



SR-TEN5-C

5' STRAIGHT SHOWER ROD

SRS-60-?

- BN Brushed Nickel Rod
- C Chrome Rod
- MB Matte Black Rod
- ORB Oil Rubbed Bronze Rod
- PB Polished Brass Rod
- W White Rod

6' STRAIGHT SHOWER ROD

SRS-72-?

- BN Brushed Nickel Rod
- C Chrome Rod
- MB Matte Black Rod
- W White Rod

L- & D-SHAPED SHOWER RODS

Protect nearby walls and the bathroom floor surrounding your tub with the L- or D-Shaped shower rod. Allows your curtain to completely encircle a tub and includes ceiling support and wall flanges.

L-SHAPED SHOWER ROD

- Shower rod is adjustable by cutting ends
- Perfect for corner applications
- Available in 72" x 36"
- Includes 36" ceiling support.

D-SHAPED SHOWER ROD

- Available in 54" x 27" and 60" x 27"
- Includes 36" ceiling support.



L-SHAPED SHOWER ROD



D-SHAPED SHOWER ROD

L-SHAPED SHOWER ROD ORDER INFORMATION:

SRL-7236-?

BN Brushed Nickel Rod
C Chrome Rod
ORB Oil Rubbed Bronze Rod
PB Polished Brass Rod

D-SHAPED SHOWER ROD ORDER INFORMATION:

SRD-5427-?

BN Brushed Nickel Rod - 54" x 27"

D-SHAPED SHOWER ROD ORDER INFORMATION:

SRD-6027-?

PB Polished Brass Rod - 60" x 27"

SHOWER ROD HOOKS AND RINGS

Complete your shower rod installation with a set of roller rings and double shower hooks

ROLLER RINGS

- Smooth-rolling ball bearings
- Eliminates snagging, tugging and pulling
- Corrosion resistant
- Fits any shower curtain and rod type
- Set of 12



ROLLER RINGS

DOUBLE SHOWER HOOKS

- Perfect for hanging a shower curtain and liner
- Simply place on your curtain rod, and you're ready to go
- Set of 12



DOUBLE SHOWER HOOKS

ROLLER RINGS

ORDER INFORMATION:

RR-?

B Brass
BN Brushed Nickel
ORB Oil Rubbed Bronze
S Stainless Steel

DOUBLE SHOWER HOOKS

ORDER INFORMATION:

SRO-DBLHK-?

S Stainless

GRAB BARS INSTALLATION ACCESSORIES

Ensure you have the right tools to install your new designer grab bars with a carbide drill bit and hardware installation kit.

HARDWARE INSTALLATION KIT

- Includes anchors and screws



INSTALLATION KIT

CARBIDE DRILL BIT

- Apache 200 3/4 Carbide drill bit



CARBIDE BIT

HARDWARE INSTALLATION KIT ORDER INFORMATION:

GB-W-IT-KIT

White Rod

CARBIDE DRILL BIT ORDER INFORMATION:

GB-W-IT-BIT

Carbide Drill Bit

EPC TECTITE PUSH FITTINGS KIT

EPC Tectite push fittings are used to install mixer valves.

- Simple no leak push-fit fittings



.5" AQUAPEX TUBING



TT-200



TT-203



TT-204



TT-207



TT-2707-3-5



TT-211



TT-217



TT-RT



TT-201



TT-V



TC-150



TEFLON TAPE



TT-CLIPS



TT-KIT

EPC TECTITE PUSH FITTINGS ORDER INFORMATION:

AQUA

AQUA .5" AQUAPEX 100 ft Roll

EPC TECTITE PUSH FITTINGS ORDER INFORMATION:

TT-?

- 200 Push-Fit .5" Coupling
- 201 Push-Fit Slip Coupling
- 203 Push-Fit .5" Female Adapter
- 204 Push-Fit .5" Male Adapter
- 207 Push-Fit 90° Elbow
- 2707-3-5 Push-Fit 90° Drop Ear
- 211 Push-Fit .5" Tee
- 217 Push-Fit .5" Tube Cap
- RT Push-Fit Removal Tool
- V Push-Fit .5" Ball Valve

TUBING CUTTER W/DEBURRING TOOL ORDER INFORMATION:

TC-?

- 150 Tubing Cutter w/Deburring Tool

TEFLON TAPE ORDER INFORMATION:

TEFLON TAPE

EPC TECTITE PUSH FITTINGS KIT ORDER INFORMATION:

TT-KIT

Each Fitting in Various Quantities With Carrying Case

Bathtub & Shower

Seating



BENCH SHOWER SEAT

Get the ultimate safety and comfort with the Bath Planet Bench Shower Seat design. Now offered in all basic and premium colors, for a fully color coordinated system.

- Heavyweight stainless steel bracket and screws included
- Can support up to 2,200 lbs
- Designed for bathers of all sizes
- Can be installed at any custom height
- Built-in weep hole in back
- Concealed bracket installation
- Constructed from durable ABS-backed acrylic
- Backed with structural fiberglass
- Left or right hand construction
- **Dimensions:** 26"W x 14"D x 2"H



COLOR OPTIONS:

White	Classic Concrete (M)	River Rock (M)
Almond	Evo (M)	Roman Stone (M)
Biscuit	Galena (M)	Silver White Marble
Gray	Lightning (M)	Travertine
Sandbar	Linen (M)	Tuscany
Bianco Travertine	Madeira Granite	
Brecchia (M)	Metapeake (M)	
Calcutta Marble	Pompeii Marble	

CORNER HEXAGON SHOWER SEAT

Get the ultimate safety and protection with Bath Planet's classic shower seat design.

- Heavyweight stainless steel bracket and screws included
- Can support up to 980 lbs
- Built-in weep hole in back
- Concealed bracket installation
- Can be installed at any custom height
- Constructed from durable ABS-backed acrylic
- Backed with structural fiberglass
- Right or left hand applications
- **Dimensions:** 28" W x 20.25" D x 1.75" H



CORNER SEAT

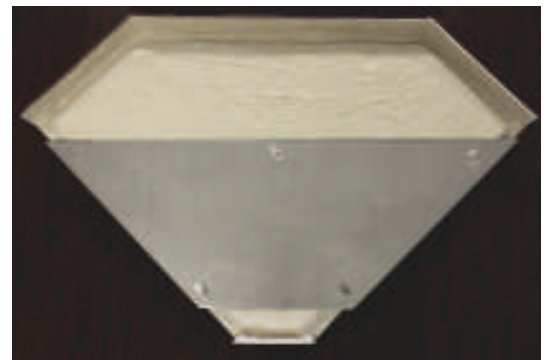

UNDERSIDE OF CORNER SEAT

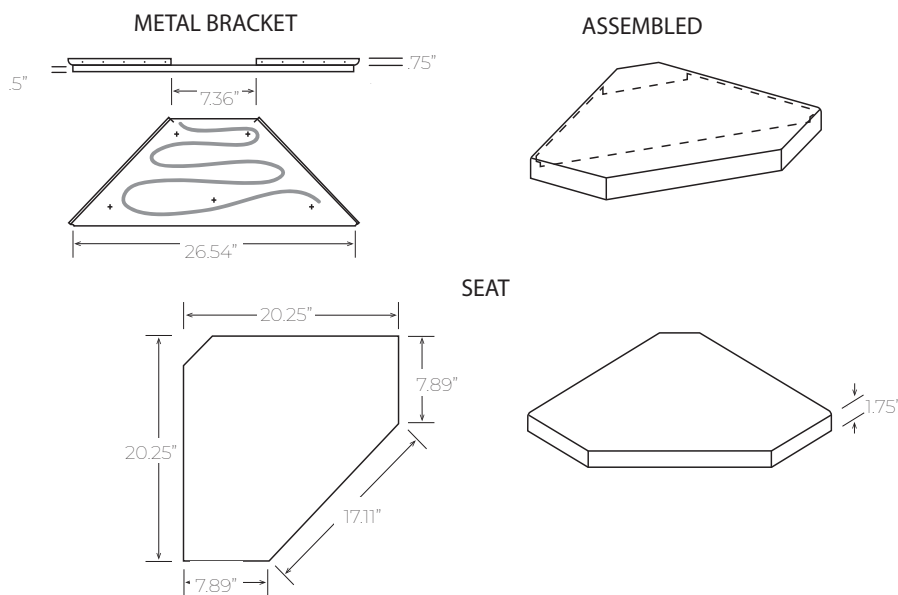

COLOR OPTIONS:

White	Classic Concrete (M)	River Rock (M)
Almond	Evo (M)	Roman Stone (M)
Biscuit	Galena (M)	Silver White Marble
Gray	Lightning (M)	Travertine
Sandbar	Linen (M)	Tuscany
Bianco Travertine	Madeira Granite	
Brecchia (M)	Metapeake (M)	
Calcutta Marble	Pompeii Marble	

BATHTUB AND SHOWER SEATING



ACRYLIC BENCH SEAT

**ACRYLIC BENCH SEAT
(2000# WEIGHT
CAPACITY)
ORDER INFORMATION:**

LBS-(L/R)H-?

Check color availability
on page 104



HEXAGON CORNER SEAT

**HEXAGON CORNER SEAT
(900# WEIGHT CAPACITY)
ORDER INFORMATION:**

LCNR-SS-?

Check color availability
on page 105

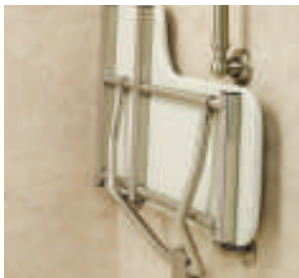

WALL MOUNTED BENCH SEAT
W/SLATS

**SEACHROME 18"x16"
1/2 FOLD DOWN
SHOWER SEAT
ORDER INFORMATION:**

SSB-180165-NW

White Naugahyde



WALL MOUNTED BENCH SEAT
W/SLATS

**SEACHROME 18"x15"
BENCH SEAT W/SLATS
(WALL MOUNTED)
ORDER INFORMATION:**

SSB2-180150-?

PW Phenolic White
PT Teak



BENCH SEAT W/SWING
DOWN LEG

**SEACHROME 24"x15"
BENCH SEAT W/SWING
DOWN LEG
ORDER INFORMATION:**

SSB2-240150-?

PW Phenolic White
TW Teak Wood
WN White Naugahyde



BENCH SEAT W/SWING
DOWN LEG

**SEACHROME 28"x15"
BENCH SEAT W/SWING
DOWN LEG
ORDER INFORMATION:**

SSB2-280150-?

PW Phenolic White
WN White Naugahyde



TEAK BENCH SEAT
W/SWING LEGS

**SEACHROME 18"x15"
TEAK BENCH SEAT
W/SWING DOWN LEGS
ORDER INFORMATION:**

SSB-180150-PT

Teak



TEAK FOLDING SEAT

**Liquid Accents Silhouette
Cameo Teak Wood Tub
& Shower Seat
ORDER INFORMATION:**

LA-TSEAT-?

BN Brushed Nickel
C Chrome
MB Matte Black
W White



SILHOUETTE SLIMLINE
WALL MOUNTED FOLDING
SHOWER SEAT

**SILHOUETTE SLIMLINE
WALL MOUNTED
FOLDING SHOWER SEAT
ORDER INFORMATION:**

SSB-185155-PBS
SSB-185155-PWS

White
Black



COMPOSITE FOLDING SEAT

**Liquid Accents
Composite Seat
ORDER INFORMATION:**

LA-CSEAT-?

See all color options on
page 112

BATHTUB AND SHOWER SEATING



L-SHAPE CUSHIONED SHOWER SEAT

SEACHROME 28"X22.5" L-SHAPE CUSHIONED SHOWER SEAT (LEFT HAND)
ORDER INFORMATION:

SSL-280225-?

 NW White Naugahyde



L-SHAPE CUSHIONED SHOWER SEAT

SEACHROME 28"X22.5" L-SHAPE CUSHIONED SHOWER SEAT (RIGHT HAND)
ORDER INFORMATION:

SSR-280225-?

 NW White Naugahyde



L-SHAPE SHOWER SEAT

SEACHROME 32"X22.5" L-SHAPE SHOWER SEAT (LEFT HAND)
ORDER INFORMATION:

SSL-320225-?

 NW White Naugahyde
 PW Phenolic White



L-SHAPE SHOWER SEAT

SEACHROME 32"X22.5" L-SHAPE SHOWER SEAT (RIGHT HAND)
ORDER INFORMATION:

SSR-320225-?

 NW White Naugahyde
 PW Phenolic White



L-SHAPE SHOWER SEAT

22"X15"X19"H SHOWER SEAT (250# WEIGHT CAPACITY)
ORDER INFORMATION:

G-22 -?

 A Almond
 B Biscuit



TUB BENCH SEAT

MOEN HOME CARE 15"X28" TUB BENCH (250# WEIGHT CAPACITY)
ORDER INFORMATION:

BL-ST-28-W

 White



ADJUSTABLE TUB & SHOWER SEAT

MOEN HOME CARE 23.5"X14.2" ADJUSTABLE TUB AND SHOWER SEAT
ORDER INFORMATION:

MOE-DN7025

 White



TRANSFER BENCH

MOEN HOME CARE 22.2"X19.5"X8.8" TRANSFER BENCH
ORDER INFORMATION:

MOE-DN7065

 Glacier White



ADJUSTABLE TUB & SHOWER SEAT

MOEN HOME CARE GLACIER SHOWER CHAIR (400# WEIGHT CAPACITY)
ORDER INFORMATION:

MOE-DN7100

 Glacier White



PREMIUM TRANSFER BENCH

MOEN HOME CARE PREMIUM TRANSFER BENCH (400# WEIGHT CAPACITY)
ORDER INFORMATION:

MOE-DN7105

 Glacier White

LIQUID ACCENTS FOLDING COMPOSITE SEAT

Beautiful and comfortable composite safety seat. Folds up to wall to save space when not in use.

- Constructed from grade A composite, powder-coated aluminum brackets and stainless steel hardware
- Impervious to water, salt water and rust
- Easy-to-clean, low-maintenance surface
- Splinter-free assurance
- No oiling required
- Mold and mildew resistant
- Removable back slats for easy cleaning
- Complies with ADA specifications (Holds up to 400 lbs)
- 5-year warranty
- Made in the U.S.A.
- **Dimensions:** 20"W x 17.125"D x 15.375"H

Hardware Colors:



Matte Black (with Harborwood)



Silver (with Harborwood)



White (with Harborwood)

Composite Slat Colors:



Beige

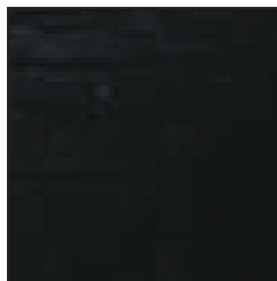

Black



Gray



Harborwood



White

Item Code: LA-CSEAT-????

Hardware:

MB = Matte Black
SV = Silver
W = White

Composite Slat:

BE = Beige
BL = Black
G = Gray
H = Harborwood
W = White

SAFETY SOFT

SEATING & FLOORING

Get the ultimate safety and protection with Bath Planet's classic shower seat design.

- This material has been tested in the boating industry and by our Research & Development team, so you can rest assured that it will function beautifully in the bathroom.
- Permanent slip-resistant mat
- Peel & stick installation
- Beveled edge for drainage
- Lightweight polymer material
- Now, comes in seven colors: Black, Bright White, Concrete Gray, Gray, Off White, Sand, Tuscan.
- **Available Dimensions:**
 - 33" x 13" for Bathtubs
 - 24" x 12" Bench Seat
 - Corner Hexagonal Seat
 - 6" x 6" Seating and Flooring sample
 - 39" x 20" Large Shower Base, Center Drain
 - 20" x 20" Large Shower Base, Center Drain
 - Alexis Walk-in Tub - Three-Piece set
 - 35" x 35" Neo Shower Mat
 - 38" x 38" Neo Shower Mat





Glass

Enclosures



LIQUID ACCENTS ALPINE SHOWER DOOR

Our newest entry to our Euro style shower doors introduces thick 5/16" glass for the most solid feel yet.

- 5/16" Thick Glass – Rounded Euro Header
- 3" Bolt-thru Glass, Two-Wheeled, Hanging Brackets
- Comes in Double and Single Ladder Towel Bar variations
- **Shower Dimensions:**
 - 48" W x 70" H
 - 60" W x 70" H
 - 60" W x 76" H
- **Tub Dimensions:**
 - 60" W x 62" H
- Multiple glass options
- Available in Four Finishes



Optional Upgrade

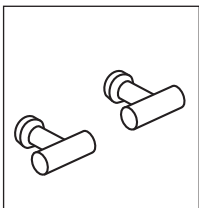

Two Finger Knobs

GLASS FINISHES



Clear

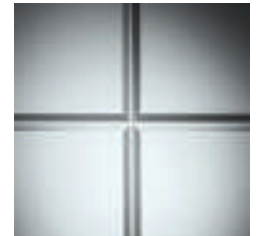

V-Groove

DOOR FINISHES

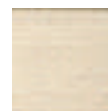

Brushed Nickel

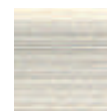

Chrome



Matte Black

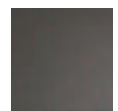

Oil Rubbed Bronze



LIQUID ACCENTS GLACIER SHOWER DOOR

Show off the new bathroom with a beautiful new glass shower enclosure.

- .25" Thick Glass – Rounded Euro Header
- Towel Bar Handle and 2 Knobs
- **Shower Dimensions:**
 - 48" W x 70" H
 - 60" W x 70" H
 - 66" W x 70" H (Clear Glass Only)
 - 72" W x 70" H (Clear Glass Only)
- **Tub Dimensions:**
 - 60" W x 57" H
 - 60" W x 62" H
- Several Glass options
- Glass Protection Included
- Available in Four Finishes
- Extra Towel Bar Available in 24"



GLASS FINISHES



Clear



Frost*

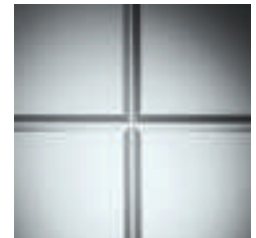

V-Groove

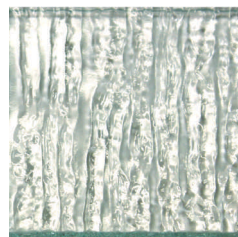

Rain



Corrugated*

Optional Upgrade

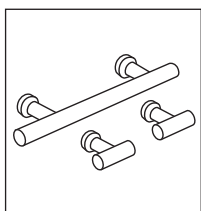

Ladder Towel Bar & Two Knobs

DOOR FINISHES



Brushed Nickel

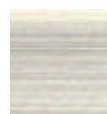

Chrome



Matte Black

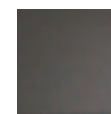

Oil Rubbed Bronze

*Frost glass is not available in all door sizes.

*Corrugated only in 60" W x 70" H



LIQUID ACCENTS GLACIER TALL

Our shower doors will make your bathroom appear more spacious, reflecting light and enhancing your space.

- .25" Thick Glass
- One Towel Bar and Two Knobs Included
- Easy Glide Wheels, Roller Brackets
- Rounded Euro Style Header
- **Dimensions:**
48" W x 76" H
60" W x 76" H
- Several Glass options
- Glass Protection Included
- Available in Four Finishes
- Extra Towel Bar options:
18" (48" doors)
24" (60" doors)



Optional Upgrade

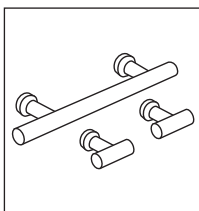

Ladder Towel Bar & Two Knobs

GLASS FINISHES



Clear

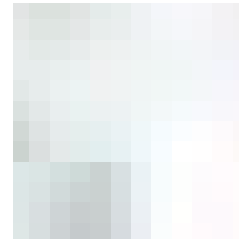

Frost*

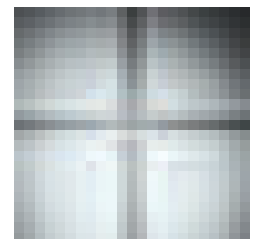

V-Groove

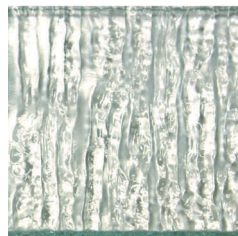

Rain



Corrugated*

FRAME FINISHES



Brushed Nickel



Chrome

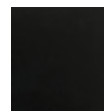

Matte Black



Oil Rubbed Bronze

*Frost glass is not available in all door sizes.

*Corrugated only in 60" W x 76" H





DENALI DOUBLE SLIDER DOOR

Elegant and modern “barn door” style look with rectangular glide bar. Specially designed roller bearings and padded stoppers allow for quiet, easy movement of the door.

- 5/16" (or .3125") thick Clear glass & 5/16" (or .3125") thick Frost* glass available for the 60" width only
- Two, sliding 31.5" x 74" glass doors
- Two, contemporary 28" Ladder Pull bars and two finger pulls included
- **Dimensions:**
60" W x 74" H
48" W x 74" H
- Available in Four Finishes*
- Multiple glass options
- Universal design works with right or left plumbing



Optional Upgrade

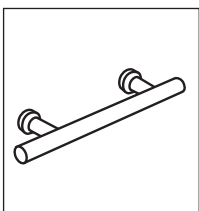

Second Ladder Towel Bar

GLASS FINISHES



Clear

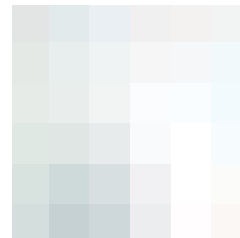

Frost*

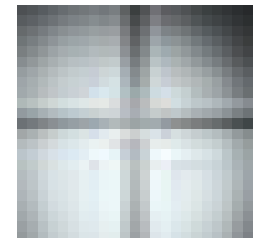

V-Groove

FRAME FINISHES



Brushed Nickel



Chrome



Matte Black



Oil Rubbed Bronze*

*Frost glass is only available for the 60" W, Clear Glass models
*Oil Rubbed Bronze finish is only available for the 48" W model

DENALI DOUBLE SLIDER DOOR - VERTICAL HANDLE

Elegant and modern “barn door” style look with rectangular glide bar. Specially designed roller bearings and padded stoppers allow for quiet, easy movement of the door. This top-seller now comes with vertical handles.

- 5/16" (or .3125") thick glass
- Multiple glass options
- Two, sliding clear glass doors
- Two, vertical Ladder Pull Handles
- **Dimensions:**
48" W x 74" H
60" W x 74" H
- Available in Brushed Nickel, Chrome, Matte Black, & Oil Rubbed Bronze* (Oil Rubbed Bronze is only available for the 48" width).
- Universal design works with right or left plumbing



GLASS FINISHES

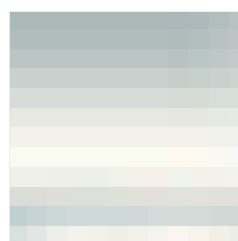

Clear

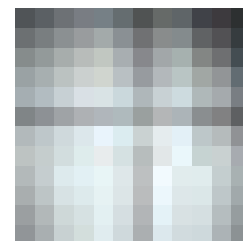

V-Groove

DOOR FINISHES



Brushed
Nickel



Chrome

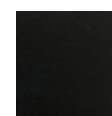

Matte
Black



Oil Rubbed
Bronze

*Oil Rubbed Bronze finish is only available for the 48" W model

DENALI DOUBLE SLIDER DOOR - TUB HEIGHT

This top-selling “barn door” now comes at the perfect size for a beautiful new tub. This is the ideal door to create a shower and tub combinations with plenty of natural lighting.

- 5/16" (or .3125") thick Clear glass
- Two, sliding 31.5" x 62" clear glass doors
- Two, contemporary 28" Ladder Pull bars and two finger pulls included
- **Dimensions:** 60" W x 62" H
- Available in Four Finishes
- Multiple glass options
- Universal design works with right or left plumbing



GLASS FINISHES

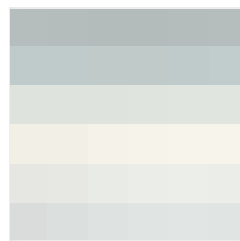

Clear

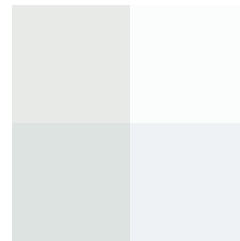

Frost*

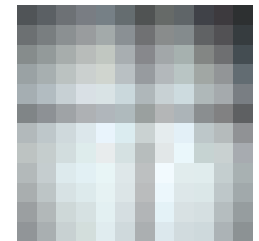

V-Groove

FRAME FINISHES



Brushed Nickel



Chrome



Matte Black



Oil Rubbed Bronze*

ARIES OUTSWING DOOR

Our Aries shower door is ideal for narrow enclosures. Easy to install and design allows for adjustable widths.

- Outswing Pivot Door
- 2-3-inch adjustment, depending upon pan size
- 1/4" Clear Glass
- Available in Three Finishes
- 27" Door Lite (with 24" Daylight Opening)
- Includes Ladder Pull Handles
- Polycarbonate Sweep
- Ease of Installation - (Installs in approximately 30 minutes)
- Optional: Glass Protection Wipe.
One glass protection wipe covers 14 sq ft
- **Dimensions:**
 - 29" – 31" W x 72" H
 - 31" – 33" W x 72" H
 - 33" – 35" W x 72" H
 - 38 1/2" – 41" W x 72" H
 - 44 1/2" – 47" W x 72" H



GLASS FINISHES

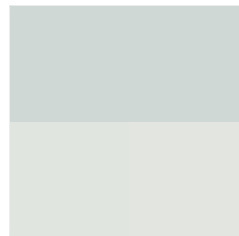

Clear

FRAME FINISHES



Brushed
Nickel

Chrome

Matte
Black

EVEREST DOOR

Our Everest series door is designed to fit into any bathroom. The 8" C-Pull handles give this shower a solid, modern feel.

- Bypass Door Design
- Euro Header Design
- Universal Design Works with RH or LH Plumbing
- Includes two single-sided, 8" C-Pulls with Finger Pulls. Optional handle upgrade to Ladder Pull Handles.
- Available in Four Finishes
- Multiple glass options
- Glass Protection Included

- **Dimensions:**
 48" W x 70" H
 60" W x 57" H
 60" W x 62" H
 60" W x 70" H
 60" W x 76" H



Optional Upgrade

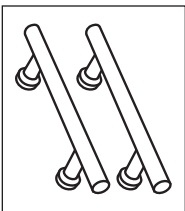

Two Vertical Ladder Pull Handles w/ Finger Pulls

*Frost glass is not available in all sizes
 * Rain glass not available in the 60" W x 57" H model

GLASS FINISHES



Clear

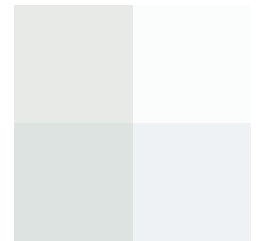

Frost*

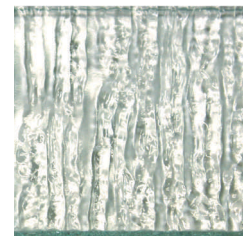

Rain

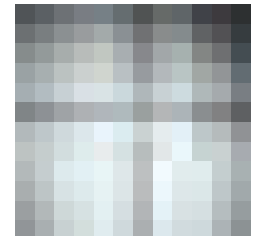

V-Groove

FRAME FINISHES



Brushed Nickel



Chrome



Matte Black

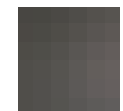

Oil Rubbed Bronze

K2 DOUBLE THRESHOLD ENCLOSURE

Our K2 Double Threshold shower door is ideal for Bath Concepts Shower bases fitted against only 2 room walls.

- Outswing Hinge Door
- 1/4" Clear Glass
- Available in Three Finishes
- Includes One Double-Sided Vertical Ladder Pull Handle
- Polycarbonate Sweep
- Glass Protection Included
- Only Designed to fit Bath Concepts manufactured Double Threshold Shower Pans
- Ease of Installation - (Installs in approximately 30 minutes)
- Optional: Glass Protection Wipe.
One glass protection wipe covers 14 sq ft
- **Dimensions:**
32" – 32" W x 72" H
36" – 36" W x 72" H



GLASS FINISHES



Clear

FRAME FINISHES



**Brushed
Nickel**

Chrome

**Matte
Black**

K2 NEO-ANGLE ENCLOSURE

Our K2 Neo-Angle Enclosure is designed to fit Bath Concepts Neo-Angle Shower Pans. Fit your dream shower into any corner with assurance of a premium glass enclosure.

- Outswing Hinge Door
- 1/4" Clear Glass
- Polycarbonate Sweep
- Includes One Double-Sided Vertical Ladder Pull Handle.
- Available in Three Finishes
- Glass Protection Included
- **Dimensions:**
 - 35" – 35" W x 72" H
 - 38" – 38" W x 72" H



GLASS FINISHES



Clear

FRAME FINISHES



**Brushed
Nickel**

Chrome

**Matte
Black**

GLASS PARTITION

Our Glass Partition is a perfect fit for a modern finish with a static panel of glass.

- Heavy 3/8" thick glass
- Available in four Finishes
- Glass Protection Included
- **Dimensions:**
 - 32" W x 74" H
 - 36" W x 74" H



GLASS FINISHES

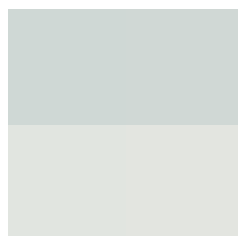

Clear

FRAME FINISHES



Brushed
Nickel

Chrome

Matte
Black

Oil Rubbed
Bronze

INVISIBLE SHIELD

Protect your new shower door with Invisible Shield Pro 15 Coating Wipes.

- Easy application with instructions included
- Repels water, soil, rust & minerals
- Prevents excess soiling, staining & corrosion
- Makes cleaning easier & improves appearance



SW-10

Installation

Accessories



INSTALLATION ACCESSORIES TUB INSTALLATION KIT

The Tub Liner Installation Kit properly secures the tub liner to the existing tub.

- Kit includes:
 - (4) Tubes color matched Duraflex® silicone
 - (2) Roll of Butyl Flat Tape
 - (1) Roll of Butyl Round Tape
 - (1) Gasket
- Kit Colors: White, Almond, Biscuit, Gray and Sandbar



IK-TUB-?

INSTALLATION ACCESSORIES SHOWER LINER INSTALLATION KIT

Properly secures the shower liner with this Shower Liner Installation Kit.

- Kit includes:
 - (4) Tubes color matched Duraflex® silicone
 - (2) Roll of Butyl Flat Tape
 - (1) DR-CVR-4
- Kit Colors: White, Almond, Biscuit, Gray and Sandbar



IK-SHRLNR-?

INSTALLATION ACCESSORIES WALL INSTALLATION KIT

All the necessities for your full wall install needs.

- Kit includes:
 - 12 Cartridges SuperTach® Wall Adhesive
 - 1 Roll of Gray Round Tape

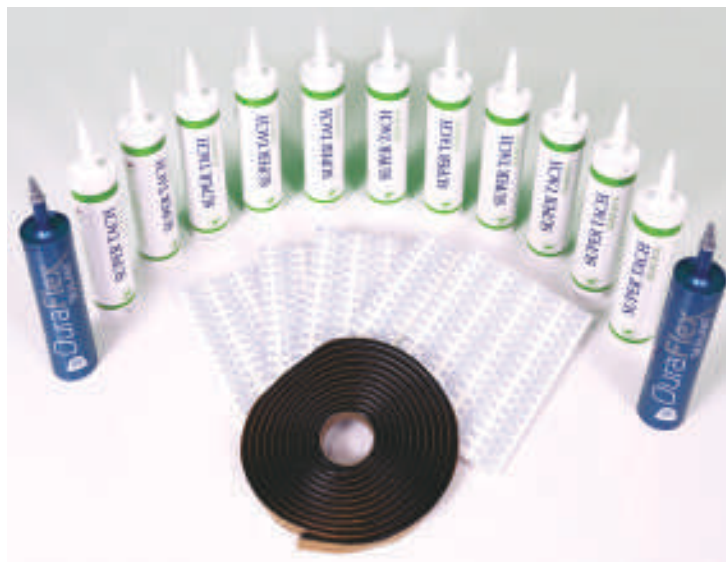

INSTALLATION ACCESSORIES SAUSAGE PACK

- No waste using sausage packs
- Sausage caulk guns distribute adhesive quickly and more efficiently than cartridges
- Each sausage pack contains 20 oz (16).



SL-16-DFWA

CAULK PRIMER

Caulk Primer primes the acrylic for improved adhesion with silicone sealants.



INSTALLATION ACCESSORIES SILICONE

Get that perfect finished look with Bath Planet's custom color matched sealant infused with mold inhibitors.

- 10.3 ounces
- Improved flow rate
- Born on date (date manufactured for tracking)
- Color identification on tube
- 12-18 Month shelf life
- Matches all wall colors



4-Pack: ADH-SL-4-?

24-Pack: SL-24-?

COLOR OPTIONS:

Almond
Biscuit
Black
Clear
Granite

Gray
Gray Translucent
Mix
Sandbar
Taffeta (G2)

Translucent
Travertine
White

INSTALLATION ACCESSORIES WALL ADHESIVE, SILICONE & PRIMER

Seal the wall seams with our adhesive products and specialty color matched silicone.

NOTE: Primers cannot be shipped via Next Day Air



BLACK OR WHITE FLAT BUTYL TAPE



4" BUTYL TAPE



WHITE ROUND TAPE



FOAM TAPE



SPECIALTY SILICONE



SUPERTACH



DURAFLEX WALL ADHESIVE



BUTYL TAPE PRIMER



SILICONE PRIMER



PRIMER CAN & BRUSH

**.75" BUTYL TAPE (8 ROLLS)
ORDER INFORMATION:**

?-CASE

FT Black
FTW White

**4" BUTYL TAPE (2 ROLLS)
ORDER INFORMATION:**

?-CASE

FT4 Black

**.375" ROUND TAPE (12 ROLLS)
ORDER INFORMATION:**

?-CASE

RT Black
RTW White

**.375" FOAM TAPE ROLL
ORDER INFORMATION:**

FT-F-?

.5 Foam Tape
.125 x .75 Foam Tape
.25 x .75 Foam Tape

**BUTYL TAPE PRIMER
ORDER INFORMATION:**

BP-?

QT Quart
G Gallon

**SILICONE PRIMER (13.5 OZ)
ORDER INFORMATION:**

SP-P

**PRIMER CAN & BRUSH
ORDER INFORMATION:**

PC-B

ANTI-SLIP RESISTANCE (8 OZ)
ORDER INFORMATION:**

ASR

**3 - 4 Applications per Bottle

**DURAFLEX SILICONE
WALL ADHESIVE
ORDER INFORMATION:**

SL-16-DFW

White

**ACETOXY SILICONE
ORDER INFORMATION:**

SL-AXYY24-?

W White - 24/Case

INSTALLATION ACCESSORIES INSTALLATION TOOLS

Use these specially designed tools to accurately transfer wall and tub measurements, simplify installation, bend and repair acrylic surfaces.



INSTANT MOLD & MILDEW STAIN REMOVER



WALL TEMPLATE



TUB INSTALLATION TEMPLATE

MP COATING - MOLD AND MILDEW PROTECTIVE COATING

ORDER INFORMATION:

MP COATING

8 oz Bottle and Pump Sprayer

WALL TEMPLATE ORDER INFORMATION:

WT

TUB INSTALLATION TEMPLATE ORDER INFORMATION:

TT

MEASURING TOOL ORDER INFORMATION:

3-PC

PORTABLE BENDING TOOL ORDER INFORMATION:

1729900-180



MEASURING TOOL



PORTABLE BENDING UNIT

INSTALLATION ACCESSORIES INSTALLATION TOOLS



CAULK TIP EXTENDER



DRAIN CENTERING TOOL



DRAIN FORMING TOOL



SCRATCH REMOVER KIT



CAULK REMOVER



INDUSTRIAL ROLLER



CAULK FINISHER



REPAIR KIT



FUGENBOY CAULK FINISHING TOOL KIT



PRIMER MARKER

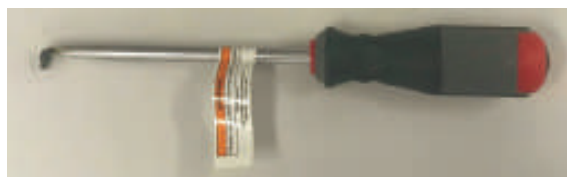

LINE HOOK TOOL



COLOR-MATCHED REPAIR KIT

DRAIN CENTERING TOOL
ORDER INFORMATION:
DR-CENTERPUNCH

DRAIN FORMING TOOL
ORDER INFORMATION:
DR-FORMINGTOOL

INDUSTRIAL ROLLER
ORDER INFORMATION:
L-WALLROLLER

SCRATCH REMOVER KIT
ORDER INFORMATION:
SREM-KIT

SCRATCH REPAIR KIT
ORDER INFORMATION:
SREP-KIT

FUGENBOY CAULK FINISHING TOOL KIT
ORDER INFORMATION:
CFT-KIT

COLOR-MATCHED REPAIR KIT
ORDER INFORMATION:
17298-?-350

04 White
01 Almond
02 Biscuit

INSTALLATION ACCESSORIES INSTALLER TOOLKIT

Contains the following items:

- 12" Hacksaw
- 48" Level
- 24" Level
- 72" Straight Edge
- Bosch T101BF 5 pc. 4" 10 TPI Variable Pitch Clean for Hardwood T-Shank Jig Saw Blades
- Channel Lock
- 6-in-1 Screwdriver
- 6" Adjustable Wrench
- 10" Pipe Wrench
- Basin Wrench
- Slip Nut Wrench
- 10 Piece Metric Hex Key
- 10 Piece Safe Hex Key
- East Wing 16oz Hammer
- Wiss Straight Cut Snips
- (3) 4'x15' Canvas Drop Cloth
- Inside PVC Pipe Cutter
- Deburring Tool
- Shoe Covers - 3 Pack
- Dust Masks - 5 Pack
- Speed Square 7"
- Firm Grip Gloves - 3 Pack
- 6-in-1 Painters Tool
- 12" Wonder Bar
- Locking Pliers - 2 Pack
- Fixed Jab Saw
- 16' Tape Measure
- Drill Bits - 7 Pack
- Tile Bits - 3 Pack
- Rigid Pipe Cutter
- Teflon Tape
- Broom and Dustpan
- 1-1/4" Whole Saw
- 5 Gallon Bucket
- (2) Rolling Bin
- Terry Cloth Rags - 20 Pack
- Denatured Alcohol
- Precision Screw Driver
- Cordless Power Tools
- Pen Light
- Flat Razor Blades - 10 Pack
- Cordless Caulking Gun
- Parts Container Tough Case
- Bucket Boss
- Sharpies - 2 Pack
- Toilet Armor

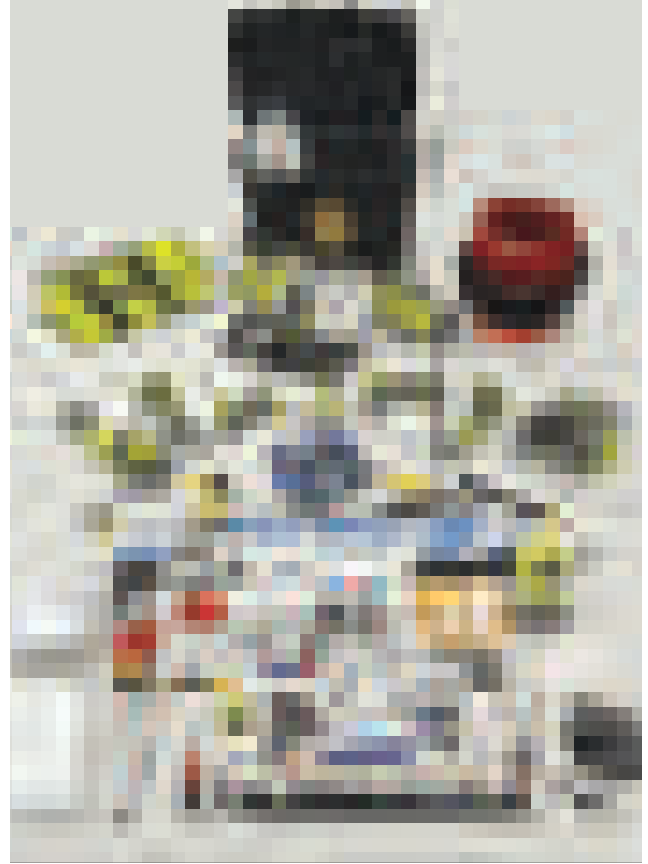

TT-TOOLKITCOMPL

Sales

Tools



ETCHED SAMPLE SETS

Wall color samples are vital for the in-home consultation process and customers love when they can actually touch the acrylic product.

- Contains etched samples of all available Bath Planet colors



COLOR OPTIONS:

White	Othello	Lightning (M)	Silver White Marble
Almond	Bianco Travertine	Linen (M)	Travertine
Biscuit	Brecchia (M)	Madeira Granite	Tuscany
Gray	Calcutta Marble	Metapeake (M)	
Sandbar	Classic Concrete (M)	Pompeii Marble	
Grayline (M&G)	Evo (M)	River Rock (M)	
London Fog	Galena (M)	Roman Stone (M)	

MICRO SHOWER DOOR SAMPLE

The Micro Shower Door promo sample is perfect for showing in the home.

- Sample of Liquid Accents Shower door
- Comes with durable carrying bag
- Available in Brushed Nickel, Chrome, Matte Black, Oil Rubbed Bronze, and Signal Gray finishes.



GLASS FINISHES



Clear

DOOR FINISHES

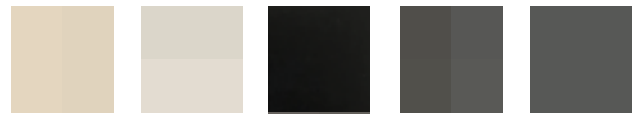

Brushed Nickel

Chrome

Matte Black

Oil Rubbed Bronze

Signal Gray

MINI COMPOSITE SEAT SAMPLE

The Mini Composite Seat Sample is the perfect all-in-one solution to help homeowners visualize the options of the new seating option.

- Scale model of the Liquid Accents Composite Seat
- All hardware and slat color options are represented
- Composite slat color names are etched into the material
- **Dimensions:** 8.25"W x 7.25"H x 6.5"D



SAM-LA-CSEAT

MICRO TUB PROMO

The mini tub promo sample is perfect for showing in the home.

- Constructed from DR-ABS acrylic
- Available in White
- .25" Thick
- **Dimensions:** 10.5"L x 5.5"D x 2.75"



DIS-MICRO-W

MICRO SHOWER PROMO

The mini shower promo sample is perfect for showing in the home.

- Constructed from DR-ABS acrylic
- Available in White
- Over .125" Thick
- **Dimensions:** 8.5"L x 7.25"D x 1.25"H



DIS-MICRO-SF

ROBE

The perfect housewarming gift/signing bonus for your newly signed customer! Unisex bathrobe delivers all the work-from-home comfort one needs, morning or night. Made with 100% cotton, this ever-cozy and versatile robe features a relaxed fit with a shawl collar, long sleeves, self-tying waist sash, and three convenient pockets.

- 100% thick cotton
- 3 Pockets
- Machine washable
- Available in white



LA-ROBE

BATH CARE AND MAINTENANCE INSTRUCTIONS

How to care for your beautiful, new acrylic bath or shower & wall system

GENERAL CLEANING INSTRUCTIONS:

For normal everyday cleaning, Bath Planet suggests using our very own Eliminate. It is factory-approved distinctly for all of our acrylic products. It is available for sale from your local dealer. You may also use Formula 409 or Microban 24 Hour. The use of scouring pads or abrasive cleansers will dull the surface. Should you wish to use a product not listed below, test on a small area in the corner of the skirt before applying to the entire bathtub liner. Always review individual cleansers' instructions. Rinse thoroughly after cleaning.

RECOMMENDED CLEANERS:

BCI (Soon to be Bath Concepts) Eliminate, Microban 24, Formula 409, White vinegar and water may also be used to soften mineral deposits. Use 1/2 cup Clorox Bleach per gallon of water as a disinfectant.



DO NOT USE*:

- Original Clean Shower
- Clean Shower for Plastic Showers & Glass
- Ammonia
- Aerosols
- Acetone
- Soft Scrub
- Dawn Dish Soap
- Dow disinfectant cleaner
- Scrub Free
- Fingernail polish remover
- Scouring pads
- Lestoil
- Lysol disinfectant cleaner

Use of these chemicals will cause a dull surface and chemical cracks. This will void your product warranty.

There is no need to use abrasive cleaners. Abrasive cleaners dull the gloss over a period of years. In extreme cases where the recommended cleaners do not work, use a Chore Boy or 3M Sponge pad. Make sure you use only the ones recommended for Teflon or non-stick surfaces.

DRAIN CLEANER:

CAUTION: Liquid drain cleaners are recommended over powders and/or crystal; however, when using liquid drain cleaning agents, bail the standing water out of the bathtub and remove the drain plug. Use a funnel to prevent spills and apply the chemicals directly down the drain. Always make certain that chemicals do not come in contact with the acrylic surface.

Use drain cleaners sparingly, so that they do not boil out and attack the acrylic surface.

Note: Silicone is resistant to paint.

LIMITED LIFETIME WARRANTY

Bath Planet, LLC ("Bath Planet") manufacturer of the acrylic wall surrounds, shower floors/bases, replacement bathtubs, tub liners, shower liners and acrylic accessories (collectively referred to as "Product") warrants its Product will be free of material defects for as long as the residential Customer ("Customer") owns the home where the Bath Planet Product was installed. For commercial/non-residential Customers, the term of the warranty is five (5) years. THIS WARRANTY EXCLUDES ANY WARRANTY FOR CLAIMS RELATING TO INSTALLATION/LABOR OF BATH PLANET PRODUCTS. THIS WARRANTY IS FOR PRODUCT DEFECTS ONLY. BATH PLANET DOES NOT WARRANT ANY NON-BATH PLANET MANUFACTURED PRODUCTS SUCH AS FAUCETS, SHOWER HEADS, DOORS, GRAB RAILS, AND/OR STOPPERS.

Bath Planet warrants that the surface of the Product will not materially fade, yellow, crack, bubble, or peel under normal use and when cared for under the guidelines set forth by Bath Planet. This warranty expressly prohibits the use of unapproved cleaners, and expressly excludes damage resulting from the use of same. In addition, this warranty is void if damage is caused by contact with any of the following: dyes, paints, inks, certain cosmetics, or cleaning agents, abrasive pads, pigments, certain foods, paint remover, fingernail polish remover, solvents or other chemicals, cigarettes or other sources of extreme heat, or abuse of any kind whether intentional or unintentional. Additional exclusions include escutcheon plates, valve handles, hand-held shower head hoses and other materials not manufactured by Bath Planet (in which case the normal manufacturer's warranty of each product applies).

In the event of a failure of the Product under these terms, Bath Planet reserves the right to partially repair, completely replace, or provide a full or partial refund, whichever Bath Planet deems appropriate in its sole discretion.

Customer may transfer this warranty to a buyer of Customer's residence ("Buyer") where the Product was installed provided the Buyer completes the acquisition of the residence within 2 years after the completion of installation of the Product, and provided the warranty has not been voided under any term set forth herein. Customers may make a warranty claim in writing with the Bath Planet Dealer with which Customer originally contracted with. Upon learning of any warranty claim, Bath Planet will take steps to assess the claim, determine a course of action and effectuate repair or other remedy under the terms of this warranty for covered Products. Any warranty work is subject to then current lead times and then current product availability. Should the Bath Planet Dealer from which the customer originally contracted for service is no longer in business, or should the customer not be able to satisfactorily resolve a warranty issue with the Bath Planet Dealer, the Customer should make a warranty claim in writing with Bath Planet. The invalidity of any provision of this warranty shall not invalidate the remaining provisions of this warranty.

ANY CLAIM FILED BY THE CUSTOMER TO ENFORCE THE TERMS AND CONDITIONS OF THIS WARRANTY SHALL BE FILED IN EITHER THE STATE COURTS SITTING IN LAKE COUNTY, ILLINOIS OR THE U.S. FEDERAL COURT FOR THE NORTHERN DISTRICT OF ILLINOIS, AND THOSE COURTS HEARING DIRECT APPEALS, IN EACH CASE TO THE EXCLUSION OF ALL OTHER JURISDICTIONS.

THIS WARRANTY IS IN LIEU OF ALL WARRANTIES, EXPRESSED OR IMPLIED, AND IS IN FACT THE ONLY WARRANTY OFFERED BY BATH PLANET. UNDER NO CIRCUMSTANCES WILL BATH PLANET BE LIABLE FOR INCIDENTAL, INDIRECT, SPECIAL, PUNITIVE, EXEMPLARY OR CONSEQUENTIAL DAMAGES (INCLUDING BUT NOT LIMITED TO DAMAGE TO PERSONAL PROPERTY, LEGAL SERVICES, AND LOSS OF TIME OR TRAVEL) UNDER THIS WARRANTY. THIS WARRANTY EXPRESSLY EXCLUDES LOSS OF VALUE, LOSS OF USE, STIGMA AND DIMINUTION IN VALUE RELATED TO ANY COVERED FAILURE CLAIMED UNDER THIS WARRANTY. IN NO WAY SHALL THE TOTAL LIABILITY OF BATH PLANET EXCEED THE TOTAL AMOUNT PAID BY THE CUSTOMER FOR SERVICES PROVIDED AND/OR THE GOODS PURCHASED. THE RESIDENTIAL BUYER SPECIFICALLY WAIVES ALL IMPLIED WARRANTIES AND THE WARRANTY FOR FITNESS FOR A PARTICULAR PURPOSE AND/OR THE IMPLIED WARRANTY OF HABITABILITY. THIS WARRANTY GIVES YOU CERTAIN LEGAL RIGHTS. SOME STATES DO NOT ALLOW LIMITATIONS OF THE IMPLIED WARRANTIES OR CONSEQUENTIAL DAMAGES, SO THESE LIMITATIONS MAY NOT APPLY TO YOU. SUBJECT TO APPLICABLE LAWS THIS WARRANTY APPLIES TO ALL SUCH LIMITATIONS TO THE FULLEST EXTENT ALLOWED BY LAW. THE WARRANTY OBLIGATIONS OF BATH PLANET ARE VOID AND OF NO AFFECT IF THE CUSTOMER HAS FAILED TO PAY FOR ANY GOODS OR SERVICES. THIS WARRANTY ONLY EXTENDS TO THE PRODUCTS AS DEFINED HEREIN AND EXCLUDES ALL OTHER PRODUCTS, SERVICES OR LABOR THAT MAY HAVE BEEN PROVIDED TO YOU.





BathPlanet®

BY BATH CONCEPTS

BATHPLANET.COM

888.9BATHPLANET
(888.922.8475)



Colors may appear different than shown.
Products and specifications are subject to change without notice.
Each Bath Planet authorized dealership is independently owned and operated.

©2025 Bath Planet, LLC. A division of Bath Concepts Industries. All rights reserved.

BP-PG 10_25 V2